

**NATIONAL WEATHER SERVICE MANUAL 10-1315**

**October 9, 2017**

**Operations and Services**

**Surface Observing Program (Land), NDSPD 10-13**

**Cooperative Station Observations and Maintenance**

**NOTICE:** This publication is available at: <http://www.nws.noaa.gov/directives/>.

**OPR:** W/OBS31 (T. Trunk)

**Certified by:** W/OBS3 (M. B. Miller)

**Type of Issuance:** Routine

**SUMMARY OF REVISIONS:** This directive supersedes NWSM, *Cooperative Station Observations and Maintenance*, dated, April 7, 2014. Changes made reflect the NWS Headquarters reorganization effective April 1, 2015. Additional changes listed below were for clarification and digital access.

1. Replaced the term WS Form B-44, with the term ‘Station Profile’ in three locations to reflect the terminology of the Station Information System (SIS).
2. Replaced the term ‘CSSA’ with ‘SIS’ (Station Information System) for the name of the operational metadata system implemented in November 2014 for the NWS Cooperative Observer Program. Affected one page, only, page A-46.
3. Revised the URL links for updates to the *FPR-D Operations Manual*, and the *FPR-E Operations Manual*. Affected pages A-9, A-10, A-11, and A-13.
4. Separated the instructions for the initialization of Nimbus units from the MMTS units in Appendix A, Section 2.42, page A-28.
5. Removed reference of ‘MMTS-7’ in Appendix B, Section 3.1, page B-26, because this model gets replaced upon failure, and the percentage of sites that use MMTS-7 is now very small.
6. Inserted link for the SKYWARN Weather Spotter Program (NWSI 10-1807) in Appendix B, Section 7.9, page B-71.
7. Added the term ‘derecho’ and clarified the definition of ‘frost’ in Appendix B, in Section 7.4 and Section 7.5.2.e, respectively.

Signed

September 25, 2017

Joseph Pica

Date

Director, Office of Observations

**Cooperation Station Observations and Maintenance**

<b>Table of Contents</b>	<b>Page</b>
1. Purpose.....	3
2. Definition of a Cooperative Station .....	3
3. Reporting Elements.....	3
3.1 Precipitation .....	3
3.2 Air Temperature.....	3
3.3 Snow Observations .....	4
3.4 Pan Water Evaporation .....	4
3.5 Soil Temperature.....	4
3.6 River Stage.....	4
3.7 Atmospheric Phenomena .....	4
3.8 Real-Time Reporting of Precipitation, Temperatures, and Hazardous Weather Events.....	4
4. Establishing, Maintaining, and Inspecting Stations.....	5
5. Observer Training .....	5
6. Supporting Documents Online.....	5
<b>Appendices</b>	<b>Page</b>
A. NWS Representatives (NWSREP) Maintenance Instructions.....	A-1
B. Cooperative Observer Observation Instructions .....	B-1

1. Purpose. The purpose of this manual is to provide guidelines for taking and reporting climate and weather observations at cooperative observer program (COOP) stations. The instructions pertain to the exposure, operation, maintenance of instruments, and equipment used by the cooperative observer.

2. Definition of a Cooperative Station. A National Weather Service (NWS) cooperative weather observing station, under the direction of the NWS, is a location at which weather observations are taken or other services rendered by private citizens, institutions or by other government agencies. Services rendered usually consist of taking instrumental or visual observations, recording data and transmitting reports. The equipment is usually owned by the NWS, but may be owned by an individual company, another government agency (Local, Territorial, State, Federal), or privately owned by the cooperative observer.

The equipment complies with NWSI 10-1302, *Requirements and Standards for Climate Observations*, (<http://www.nws.noaa.gov/directives/sym/pd01013002curr.pdf>), and the station siting complies with standards set in NWSI 10-1307, *Cooperative Program Management and Operations*. (<http://www.nws.noaa.gov/directives/sym/pd01013007curr.pdf>).

3. Reporting Elements. Although the majority of cooperative stations record precipitation amount and maximum and minimum temperature, each station is unique. For example, one station may record precipitation only, while another station may record precipitation, temperature, and evaporation. One or more of the following elements may be reported:

- a. Precipitation
- b. Air Temperature
- c. Snow Observations
- d. Pan Water Evaporation
- e. Soil Temperature
- f. River Stage
- g. Atmospheric Phenomena

3.1 Precipitation. Measurements are taken and recorded daily of the amount of rainfall, snowfall (new snow), depth of snow, and for other forms of precipitation. Records are kept of the character, type, and time of occurrence. Each station is usually furnished with a non-recording or a weighing-type recording gauge.

3.2 Air Temperature. Measurements of the current air temperature and the maximum and minimum temperatures between observations are taken and recorded daily. Cooperative stations are provided with maximum and minimum thermometers and an instrument shelter for housing the thermometers, or an electronic thermometer system.

3.3 Snow Observations. There are four categories of observations: snowfall, snow depth, snowfall water content, and snow depth water content. The NWS policies and procedures for taking snow observations are given by, *Snow Measurement Guidelines for NWS Surface Observing Programs*. Access the [Snow Measurement Guidelines \(2013\)](#) from this link.

3.4 Pan Water Evaporation. Daily measurements of the amount of evaporation observed from an open, freely exposed pan are taken and recorded. Measurements are made of wind movement over the pan, temperature of the water, and temperature of the air. The stations are provided with:

- a. An evaporation pan with stilling well and calibrated refill cylinder.
- b. A totalizing anemometer.
- c. A maximum and minimum thermometer.

3.5 Soil Temperature. Selected stations record the soil temperatures daily. These stations are provided with soil thermometers or sensing elements to be installed at selected depths under undisturbed bare soil or under grass-covered soil.

3.6 River Stage. Some stations take daily observations of river stages. The NWS furnishes an appropriate river gauge for the station.

3.7 Atmospheric Phenomena. Weather occurrences such as rain, cloud cover, hail, and thunderstorms are considered to be atmospheric phenomena. Phenomena of severe enough nature to threaten life and property are usually reported when they take place, rather than waiting to report them at the scheduled time of observation.

3.8 Real-Time Reporting of Precipitation, Temperatures, and Hazardous Weather Events. Cooperative observers are requested to report precipitation values (and in some cases temperature readings) to an NWS office, once per day or whenever a certain minimum amount of precipitation has fallen. During the winter, the observer may be requested to measure and report the water content (water equivalent) of snow on the ground.

This information helps the NWS forecast the amount of runoff and potential flooding from snow melt during warm spells or the spring thaw. Some observers maintain precipitation gauges from which the data are automatically interrogated by telephone or satellite.

The NWS Representative (NWSREP) may also ask the cooperative observer to report immediately by telephone any severe weather event that may endanger life and property. Inform the observer of the NWS SKYWARN Program, <http://www.weather.gov/skywarn/>. This information will aid in determining the need for warnings of severe weather.

If the cooperative observer agrees to participate in this program, the observer should be asked to report one or more of the following types of events.

- a. Flash flooding (observer should provide the time of the observation and state if the water level is rising or falling);
- b. Severe thunderstorms with damaging winds (58 mph or stronger) or 1.00 inch or larger hail;
- c. Excessive rain; i.e., 0.50 or 1.00 inch or more per hour; and,
- d. Unusual snow accumulation (4 inches or more, or as instructed).

This special reporting is entirely voluntary and is not intended to interfere with the regular weather duties agreed to by the cooperative observer with the NWS. However, these extra reports can be a valuable means of saving lives and minimizing the destruction of property.

4. Establishing, Maintaining, and Inspecting Stations. The NWS Representative (NWSREP) refers to Appendix C, of the NWSI 10-1307, *Cooperative Program Management and Operations*' to understand and execute the policies for establishing, maintaining, and inspecting COOP sites. See the NWS National Directives System (NDS) website: <http://www.nws.noaa.gov/directives/sym/pd01013007curr.pdf>.

The NWSREP refers to NWSI 10-1302, *Requirements and Standards for NWS Climate Observations*, for specific guidance on siting the COOP observing instruments. The policy is found on NDS website: <http://www.nws.noaa.gov/directives/sym/pd01013007curr.pdf>.

5. Observer Training. When establishing a station, the NWSREP will train the observer in the established techniques for taking a weather observation, recording the data, and the maintenance and care of instrumentation. The NWSREP will also train the observer in the safety and environmental work practices as outlined in NWSM 50-1115, *Occupational Safety and Health*, (<http://www.nws.noaa.gov/directives/sym/pd05011015curr.pdf>) and NWSM 50-5116, *Environmental Management* (<http://www.nws.noaa.gov/directives/sym/pd05051016curr.pdf>).

For a new observer, the NWSREP should closely monitor WxCoder (the web-based remote observation reporting system) or the Interactive Voice-Remote Observation Collection System (IV-ROCS) data entries, and provide positive or constructive feedback during the first month. During each site visit the NWSREP should discuss with the observer any problems with observing and recording weather data and any lapses with respect to the care and maintenance of the instrumentation.

6. Supporting Documents Online. Due to the highly technical nature of the modern observing instruments, specific sections of this manual refer readers to a website where they can access documents that give detailed instruction and policy for proper operation and maintenance of the subject instrument. Source policies for safety and environmental management are also referenced by website within the relevant sections throughout this manual of the National Directives System (NDS).

# APPENDIX A – NWS Representative (NWSREP) Maintenance Instructions

Table of Contents	Page
1. Rain Gauge Instrumentation .....	A-5
1.1 Eight-Inch Non-Recording Standard Rain Gauge .....	A-6
1.1.1 Installation.....	A-7
1.1.2 Maintenance.....	A-7
1.2 Four-Inch Non-Recording Plastic Rain Gauge .....	A-8
1.2.1 Installation.....	A-8
1.2.2 Maintenance.....	A-8
1.3 Fischer-Porter Rebuild (FPR) Recording Gauges.....	A-8
1.3.1 FPR-D (Sutron) Rain Gauge Maintenance .....	A-9
1.3.2 FPR-E (CES) Rain Gauge Maintenance .....	A-9
1.3.3 FPR System Configuration Requirements .....	A-9
1.3.4 Data Acquisition and Security Requirements .....	A-9
1.3.5 Rain Gauge Calibration Policy .....	A-10
1.3.6 Data Quality Review.....	A-11
1.3.7 Data Handling Cautions.....	A-12
1.3.8 Submitting Monthly Files to NCEI.....	A-13
1.3.9 Records Retention Policy for FPR.....	A-13
1.3.10 FPR Log Sheet Responsibility .....	A-13
1.4 Fischer-Porter Mechanical Recording Gauge (Punch Tape) .....	A-15
1.4.1 Setting the Tape to the Correct Time.....	A-16
1.4.2 Operation and Maintenance for Punch Tape .....	A-16
1.5 Fischer-Porter Maintenance Schedule .....	A-16
1.5.1 Inspect Exterior Surfaces and Routine Cleaning .....	A-19
1.5.2 Bucket Draining.....	A-19
1.5.3 Summer Maintenance .....	A-19
1.5.4 Winter Maintenance.....	A-20
2. Air Temperature Instrumentation .....	A-22
2.1 Introduction.....	A-22
2.2 Siting Requirements.....	A-22
2.3 Shelter Requirements and Maintenance.....	A-22
2.4 Types of Thermometers .....	A-24
2.4.1 Liquid-In-Glass Maximum/Minimum Thermometers .....	A-24
2.4.1.1 Maximum Thermometer – How It Works .....	A-24
2.4.1.2 Minimum Thermometer – How It Works.....	A-25
2.4.1.3 Mounting and Maintaining the Thermometers Support.....	A-25
2.4.1.4 Mercury Clean-Up .....	A-26
2.4.2 Electronic Thermometers.....	A-27
2.4.2.1 Initial Checkout of Instrument .....	A-27
2.4.2.2 Calibration.....	A-29
2.4.2.3 Nimbus Susceptibility.....	A-29

3. Pan Water Evaporation Instrumentation.....	A-30
3.1 Introduction.....	A-30
3.2 Setting Up the Observation Site.....	A-30
3.2.1 Exposure of Equipment.....	A-30
3.2.2 Plot Layout.....	A-31
3.2.3 Enclosure.....	A-31
3.3 Evaporation Pan.....	A-32
3.3.1 Installation.....	A-32
3.3.2 Maintenance.....	A-32
3.3.3 Control of Algae.....	A-33
3.3.4 Water Storage Tank.....	A-33
3.4 Measuring Instruments.....	A-33
3.4.1 Fixed Point Gage.....	A-33
3.4.2 Hook Gage.....	A-35
3.5 Totalizing Anemometers.....	A-35
3.5.1 Installation.....	A-35
3.5.2 Maintenance.....	A-35
3.5.3 Wind Movement Readings.....	A-35
3.5.4 Data From 5-Digit Counter Anemometers.....	A-36
3.5.5 Data From 6-Digit Counter Anemometers.....	A-37
3.6 Water Thermometers.....	A-38
3.6.1 Submerged-Mount Thermometers.....	A-38
3.6.2 Recording Thermometers.....	A-38
3.6.3 Long Stem Digital Max/Min Thermometers.....	A-38
3.6.4 Maintenance - Long Stem Digital Max/Min Thermometers.....	A-39
4. Soil Temperature Instrumentation.....	A-40
4.1 Introduction.....	A-40
4.2 Site Requirements and Maintenance.....	A-40
4.2.1 Instrument Exposure.....	A-40
4.2.2 Sod-Covered Plots.....	A-40
4.2.3 Natural Cover.....	A-40
4.2.4 Bare Soil.....	A-40
4.2.5 Snow Cover.....	A-41
4.3 Depth of Soil Temperature Measurements.....	A-41
4.4 Types of Thermometers and Readings.....	A-41
4.5 Installation of Thermometers.....	A-41
4.6 Shelter for the Readings Display.....	A-42
4.6.1 Types of Head Shelters.....	A-42
4.6.2 Location of Shelter.....	A-43
4.7 On-Site Accuracy Checks.....	A-43
4.7.1 Palmer Thermometer.....	A-43
4.7.2 Palmer Model 35B.....	A-44
4.7.3 Calibration of the Palmer Thermometers.....	A-44
4.8 Maintenance of the Palmer Thermometers.....	A-45
4.8.1 Loose Pointers.....	A-45

4.8.2	Frozen Pointers .....	A-45
4.8.3	Moisture in the Head.....	A-45
4.8.4	Broken Cover .....	A-45
5.	River Stage Instrumentation .....	A-46
5.1	Introduction.....	A-46
5.2	Safety Precautions.....	A-46
5.3	River Gauge Location .....	A-47
5.3.1	Site Selection Criteria .....	A-47
5.3.2	Relocating River Gauges .....	A-48
5.4	Staff River Gauge .....	A-48
5.5	Wire Weight Gauge .....	A-49
5.5.1	Description.....	A-49
5.5.2	Installation.....	A-50
5.5.3	Re-Installing a Wire Weight Gauge at an Established Site .....	A-51
5.5.4	Replacement of a Lost Weight.....	A-52
5.6	Profile Gauge .....	A-54

<b>Figures</b>	<b>Page</b>	
A-1	Wind Shield .....	A-5
A-2	Eight-Inch Gauge.....	A-5
A-3	Fischer-Porter Gauge Mounted on a Snow Tower with Wind Shield .....	A-6
A-4	Eight-Inch Precipitation Gauge Components .....	A-7
A-5	Measuring Stick for Eight-Inch Gauge.....	A-7
A-7	Four-Inch Plastic Gauge .....	A-8
A-8	Measuring Tube is Marked in Hundredths of an Inch.....	A-8
A-9	FPR Plotting Macro Graphs Bucket Levels and Voltage .....	A-12
A-10	FPR Log Sheet (NWSREP Provides to Observers).....	A-14
A-11	Recorder Components Fischer-Porter Mechanical Gauge – Casing Removed .....	A-15
A-12	Fischer-Porter Recording Rain Gauge .....	A-19
A-13	Instrument Shelters: Cotton Region Shelter and Two MMTS Shelters .....	A-23
A-14	MMTS Shelter .....	A-23
A-15	Minimum Thermometer and Maximum Thermometer in Position .....	A-24
A-16	Maximum Thermometer (Contains Mercury) .....	A-24
A-17	Minimum Thermometer – How to Read Index .....	A-25
A-18	Townsend Support for Maximum/Minimum Thermometers .....	A-26
A-19	MMTS-1 Original.....	A-27
A-20	MMTS-7 Upgrade .....	A-27
A-21	Nimbus Display Unit .....	A-27
A-22	Evaporation Station Plot Layout Example .....	A-31
A-23	Evaporation Pan with Stilling Well and Totalizing Anemometer .....	A-32
A-24	Stilling Well, Fixed Point Gage and Measuring Tube.....	A-34
A-25	Hook Gage.....	A-35
A-26	Totalizing Anemometer (Legacy).....	A-36
A-27	Totalizing Anemometer with 6-Digits.....	A-37



A-28	Totalizing Anemometer (ASN Part F106-1) .....	A-37
A-29	Six's Thermometer .....	A-38
A-30	Submerged Mount Thermometer.....	A-38
A-31	PVC Holder for Long Stem Digital Thermometer .....	A-39
A-32	Position the Long Stem Probe into Shaded Side of Pan.....	A-39
A-33	Battery Cell for Long Stem Thermometer.....	A-39
A-34	Installation of Soil Thermometers .....	A-42
A-35	Palmer Soil Thermometer Display in Shelter .....	A-43
A-36	Palmer Soil Thermometer.....	A-45
A-37	Staff Gauge .....	A-48
A-38	Reading the Staff Gauge.....	A-49
A-39	View of Wire Weight Gauge Inside Metal Box .....	A-50
A-40	Install the Brass Weight Securely in Five Steps.....	A-53
A-41	Profile Gauge.....	A-54

**Tables**

**Page**

A-1	Fischer-Porter Accuracy Tolerance – Calibration Reset Not Required.....	A-11
A-2	Semi-Annual Check – For All Models of Fischer-Porter Gauge .....	A-18
A-3	Propylene Glycol Schedule for Extreme Cold Sites.....	A-20
A-4	Installation and Check-out of Nimbus Display Units.....	A-28
A-5	Installation and Check-out of MMTS Display Units.....	A-28

## 1. RAIN GAUGE INSTRUMENTATION

In its simplest form, a precipitation gauge is an open-mouthed can with straight sides and the open end that faces upward with the mouth positioned level as determined by a carpenter's level. Precipitation gauges are commonly called rain gauges. Recording gauges record the amount of precipitation every 15 minutes to an electronic database or to a paper punch tape.

The specific types of rain gauges approved for the Cooperative Observer Program, are:

- a. Eight-Inch Gauge (non-recording)
- b. Four-Inch Gauge (non-recording)
- c. Fischer -Porter Mechanical Gauge (paper recording)
- d. Fischer-Porter Rebuild –Type D Gauge (electronic recording)
- e. Fischer-Porter Rebuild –Type E Gauge (electronic recording)

Accurate and consistent measurements are obtained from properly exposed precipitation gauges. Gauges should not be located too close to obstructions such as trees and buildings, which cause turbulence and deflect precipitation. Gauges should not be located in wide-open spaces or on elevated sites, such as tops of buildings because of wind and resulting turbulence. The best location is where the gauge is naturally shielded in all directions (i.e., in a clearing in a grove).



Figure A-1. Wind Shield



Figure A-2. Eight-Inch Gauge

As a general rule the windier the gauge location, the greater the under catch. Gauge catch should be maximized by assuring it is unobstructed. Buildings, trees or any object that obstruct catch create a bias in the amount. Optimally, when siting a precipitation gauge, the distance of the gauge to the nearby obstruction, should always be at least equivalent to twice the height of the obstruction (i.e., not to exceed a 30° angle).

Good exposures are not always permanent. Man-made alterations to the area and the growth of vegetation may change an excellent exposure to an unsatisfactory one in a very short time. To maintain good exposure the NWSREP will have to move the gauge away from the vegetation. The NWSREP anticipates tree and hedge growth and avoids selecting a site where there is the potential for unsatisfactory exposure.

Wind shields, also known as snow shields (Figure A-1), can reduce under catch. Because of its light weight and propensity to blow about more easily than raindrops, snow is prone to under catch more than rain. Figure A-2 is an 8-inch gauge without the wind shield.

In areas where heavy snowfall occurs (i.e., mountainous areas in the western United States) gauges may be mounted on towers at a height above the maximum level to which snow accumulates, but at or somewhat below the level of tree tops. (See Figure A-3).



Figure A-3. Fischer-Porter Gauge on a Snow Tower with Wind Shield.

1.1 Eight-Inch Non-Recording Standard Precipitation Gauge. This gauge (Figure A-2) consists of a support, large diameter overflow can, a calibrated measuring stick, smaller diameter measuring tube inside the overflow can, a funnel that connects the overflow can and measuring tube (Figure A-4). The overflow can and top of the funnel are eight inches in diameter. The funnel directs precipitation into the measuring tube, which is 2.53 inches in diameter. The reduction in area from 8 inch diameter of the funnel to 2.53 inches diameter of the tube results in one to ten multiplication in the height of the volume. Therefore, 2 inches of rain entering the funnel will occupy 20 linear inches in the measuring tube, making it possible and practical to read rainfall amounts to the nearest hundredth, scaled inch.

The calibrated measuring stick is marked to indicate this expansion; 20 linear inches on the stick equals two inches of rainfall. Therefore the hundredth inch increments on the calibrated measuring stick are actually one-tenth linear inch apart (See Figure A- 5). The inner measuring tube is 20 inches tall and holds exactly 2.00 inches of rainfall. Rainfall which overflows the measuring tube is captured by the overflow can. When this occurs, note that 2.00 inches was collected in the tube. Then discard all the water in the tube. Next, carefully pour the excess water collected in the overflow can into the empty measuring tube with the funnel attached (yellow plastic piece, Figure A-4). If a heavy rainfall occurred with more than four inches, you will need to discard a second full tube, and note 4.00 inches have been measured. Then, pour the last of the contents from the overflow can into the empty tube (with funnel) and use the calibrated measuring stick to read the level of water in tube. Add this last reading, onto the initial amount (i.e., 2.00, or multiple) to determine the total rainfall.



Figure A-4. Eight-Inch Precipitation Gauge Components



Figure A-5. The Measuring Stick (brown) for Eight-Inch Gauge.

1.1.1 Installation. Before installing check the collection tube and overflow can, for leaks. Install the three leg metal support (Figure A-2) of the eight-inch standard gauge, firmly into the ground to prevent it from being overturned. Ensure the top of the gauge is level. This should be checked by laying a level across the open top of the gauge in two directions, one crossing the other at right angles.

1.1.2 Maintenance. Check the clear plastic collection tube for possible leaks and also check the overflow can for leaks. In areas that receive frozen precipitation, the funnel and inner measuring tube should be removed before any frozen precipitation event. Refer to the Snow Measurement Guidelines, on the NWS website when instructing the observer to measure snowfall water content, [Snow Measurement Guidelines \(2013\)](#). For a freezing rain event, leave the funnel in place. The funnel should be inspected and cleaned before each precipitation event to ensure an accurate catch.

Instruct the cooperative observer to report immediately any discovery of a leak in the measuring tube or overflow can to you.

Any anomaly or corrective action taken by the cooperative observer that could affect the reported observations should be noted by the observer in the WxCoder observation form (or Form B-91), to the remarks section to give the date and hours affected. Instruct the observer to report the date the anomaly or defect was discovered and the date the anomaly or defect was corrected.

1.2 Four-Inch Non-Recording Plastic Rain Gauge. The four-inch non-recording gauge (Figure A-7) consists of the outer overflow tube (four-inches in diameter), measuring tube (one-inch in diameter), a funnel (four-inch in diameter) that catches the precipitation (and directs it into the measuring tube), and a mounting bracket with screws (Fig A-7). The gauge is made of clear plastic. No measuring stick is needed because the transparent inner tube (Figure A-8) is graduated to hundredths of an inch. This measuring tube's capacity is one inch of precipitation.

The water inside the measuring tube forms a meniscus. The meniscus is the curved surface of the water as it adheres to the wall of the tube. The reading of the precipitation amount is always taken from the lowest point of the concave shaped meniscus. The reading is made when the tube is raised to eye level and held in its vertical position.



Figure A-7. Four-Inch Plastic Gauge



Figure A-8. Measuring Tube is Marked in Hundredths of an Inch

Additional amounts will flow into the overflow tube and can be measured by pouring the excess into the graduated measuring tube with the funnel attached once you discard the first inch. Read the amount of excess water and add it to 1.00 inches to get the total. Repeat these steps until all the excess water gets measured to produce the total rainfall. The gauge capacity is 11.30-inches.

1.2.1 Installation. The siting of the Four-Inch Plastic Gauge should follow the same guidelines as the standard eight-inch rain gauge. The gauge is installed on a bracket provided with the gauge and is held in place with screws driven into a post or similar permanent mount. The top of the funnel should be above the top of the post or similar mount for optimum exposure.

1.2.2 Maintenance. Little maintenance of the plastic gauge is needed. The measuring tube should be easy to read. If the plastic becomes "clouded" from exposure, the measuring tube or the gauge should be replaced. In areas that receive frozen precipitation, the funnel and inner measuring tube should be removed before any frozen precipitation event.

1.3 Fischer-Porter Rebuild (FPR) Recording Gauges. In the early 1980s the Belfort Instrument Company took over manufacturing of these gauges from the Fischer & Porter Company. Precipitation amounts are recorded at 0.1 inch increments. The bucket's capacity is approximately 20 inches of rainfall.

In 2005, the Fischer-Porter Upgrade (FPU) was introduced to a limited number of sites as the first operational electronic weighing and recording gauge. From 2009 to 2014, all of the non-telemetered Fischer-Porter mechanical gauges were converted to Fischer-Porter Rebuild (FPR) electronic weighing and recording gauges.

The lower case of the Fischer-Porter rain gauge (Figure A-11) houses the FPR rain gauge's electronic weighing sensor and the data logger. This was the location where the mechanical sensor and paper-tape recording assembly were housed.

This directive is not meant to replace the *FPR Operations Manual*, nor the *FPR Assembly Procedures*. These more technical manuals are reserved for the NWSREPs and are located on an internal NWS website: <https://www.ops1.nws.noaa.gov/Secure/COOP.html>.

1.3.1 FPR-D (Sutron) Rain Gauge Maintenance. For detailed operations and maintenance procedures, access the [FPR-D Operations Manual](#), from this link.

1.3.2 FPR-E (CES) Rain Gauge Maintenance. For detailed operations and maintenance procedures, access the [FPR-E Operations Manual](#) from this link.

Sections 1.3.3 through 1.3.15, apply to both the FPR-D and the FPR-E recording rain gauges.

1.3.3 FPR System Configuration Requirements. Each FPR system comes delivered with a manufacturer developed firmware already installed. For example the FPR-D gauge came installed with firmware named: FpRain ver 1.05.

This FPR firmware is standardized and configuration controlled. No one has authority to change the data logger configuration software without the express and written direction from the Program Management Branch (W/OBS31), Cooperative Observer Program, of the NWS.

The FPR data logger will produce two types of measurements by default: the precipitation level and battery voltage. While the logger is capable of temperature sensor input, the FPR will not be configured to input the MMTS thermistor readings.

Refer to the relevant *FPR Operations Manual* for the policy and procedures for implementing FPR Modification (Mod) Notes.

1.3.4 Electronic Data Acquisition and Security Requirements. Ask your observers to e-mail the monthly electronic FPR data to the NOAA email address you designate so you can receive, confirm, and report the data from your forecast office.

Ensure the observer meets the following requirements. The observer will be able to read the data file on their computer, even if this requires separate hardware, an SD card reader. The observer will have internet access, be able to send emails, and be able to attach a file to an email message.

Inform your observers who email their data, that NWS will **not** offer any technical support for reporting monthly data by email. For further guidance refer to the *FPR Observer Instructions*, located on the following websites, for [FPR-D Observers Guide](#) and for [FPR-E Observers Guide](#).

For those monthly electronic data files submitted in their removable memory devices (i.e., by postal service) the Weather Forecast Office (WFO) will scan and use operational virus scanning software to protect against viruses and malware. The Information Technology Officer (ITO) has the responsibility to ensure virus/malware protection systems are used by the NWSREP on all external sourced media including FPR-D SD Cards and FPR-E Flash Drives. The ITO manages a secure platform and ensures routine updates of the McAfee Active Virus Defense (AVD) dat files.

The FPR-D gauge data is retrieved by the observer with an SD Memory Card. The FPR-E gauge data is retrieved by the observer with a USB Flash Drive.

Therefore, the NWSREP follows ITO security policy as it applies to these removable media.

If your ITO scans the removable memory devices, then ensure s/he communicates this action to you. Create an accurate account of which memory devices have been scanned and saved to the WFO workstation. If you scan the removable memory devices and malware or a virus is detected, then notify your ITO and regional IT system security officer.

If malware or virus is detected, and your ITO authorizes so, you may dispose of the removable memory device according to National Institute of Standards and Technology (NIST) policy, NIST P800-88, revision 1, *Guidelines for Media Sanitization* (Sep 2012). The policy directive is accessed from the list available on: <http://csrc.nist.gov/publications/PubsSPs.html>.

Each Observer is issued just one removable memory device by the NWSREP at the time of installation when the Observer is trained. The NWSREP will have one spare removable memory device for each Observer who reports data in this mode and will mail it to the Observer if needed.

**1.3.5 Rain Gauge Calibration Policy.** The accuracy of the measurements is a function of the calibration of the weighing sensor. The calibration function and other measurement settings are Password protected. At least once per year, and preferably at the time of the semi-annual site visitation, conduct a Calibration Check-up. This requires the use of the large brass test weights. Use three test weights (each 4,111 gram size and represent five inches of rainfall) for each of the three check points, 5.0-inches, 10.0-inches, and 15.0-inches.

If the display responds with values that fall into the acceptable ranges indicated in Table A-1, then you will *not* need to re-calibrate the load cell sensor. If the display gives values outside the standards, then conduct a full calibration reset. For the mechanical Fischer-Porter gauges, follow the Gage Check instructions found in [Engineering Handbook Number 10](#), on the internal NWS website reserved for NWSREPs.

When you conduct the Semi-Annual maintenance, you should check the calibration with a clean

and dry bucket. If the Calibration Check fails to come into tolerance of  $\pm 0.25$  inch of the values listed in Table A-1, then you will need to recalibrate the FPR through the data logger. Each model has a separate set of procedures for resetting the calibration.

<b>Calibration Check Table</b>		
<b>CAL TEST POINTS</b>	<b>WEIGHTS REQUIRED</b>	<b>ACCEPTABLE RANGE</b>
5.0" equivalent rain	1 large weight	4.75 " thru 5.24"
10.0" equivalent rain	2 large weights	9.75" thru 10.24"
15.0" equivalent rain	3 large weights	14.75" thru 15.24"

Table A-1. Fischer-Porter Accuracy Tolerance - Calibration Reset Not Required

Access the [FPR Operation Manual](#) from the internal NWS website (password protected).

**1.3.6 Data Quality Review.** Recording rain gauges are prone to a number of factors that challenge the quality of the precipitation record. Small variations on the order of  $\pm 0.04$ -inches that occur several times across 24-hours are common and should not be reported.

Evaporation is the most common issue, and less common are lawn sprinklers or objects that fall into the collection bucket. If the Observer informs the NWSREP of something that could cause errors in the precipitation record, then upon receipt of the file, the NWSREP uses the FPR Plotting Macro and then views the data file in Notepad, and if validated as a data problem, the NWSREP notifies the SFSC with an email of the affected file.

These events need to be documented by the WFO and communicated to the Sterling Field Support Center (SFSC) by phone 703-661-1268, or via email, [NWS.SFSC@NOAA.GOV](mailto:NWS.SFSC@NOAA.GOV).

If warranted an Error Report can be submitted to NCEI via the Datzilla website, <http://datzilla.srcc.lsu.edu/datzilla/>. Notify your Regional COOP Program Manager if changes to the observed data were made.

Oscillations, drifts, or spikes in data that exceed  $\pm 0.04$ -inches should be reported to the SFSC via email, on: [NWS.SFSC@NOAA.GOV](mailto:NWS.SFSC@NOAA.GOV). Include a copy of the CSV or TXT file with the data aberrations.

Data plotting programs for the field office to inspect Precip Data quality were developed by NWS Engineering and Acquisition Branch for each type of data format. One was developed for CSV data; [FPR-D Plotting Macro](#), and one for TXT data; [FPR-E Plotting Macro](#).

Therefore examine the data files with the FPR Plotting Macro to get the full view of the last 100 days of recorded data.



The plotted chart (See Fig A-9) enables the NWSREP to quickly determine if there is an issue with data quality – either missing data or aberrant data.

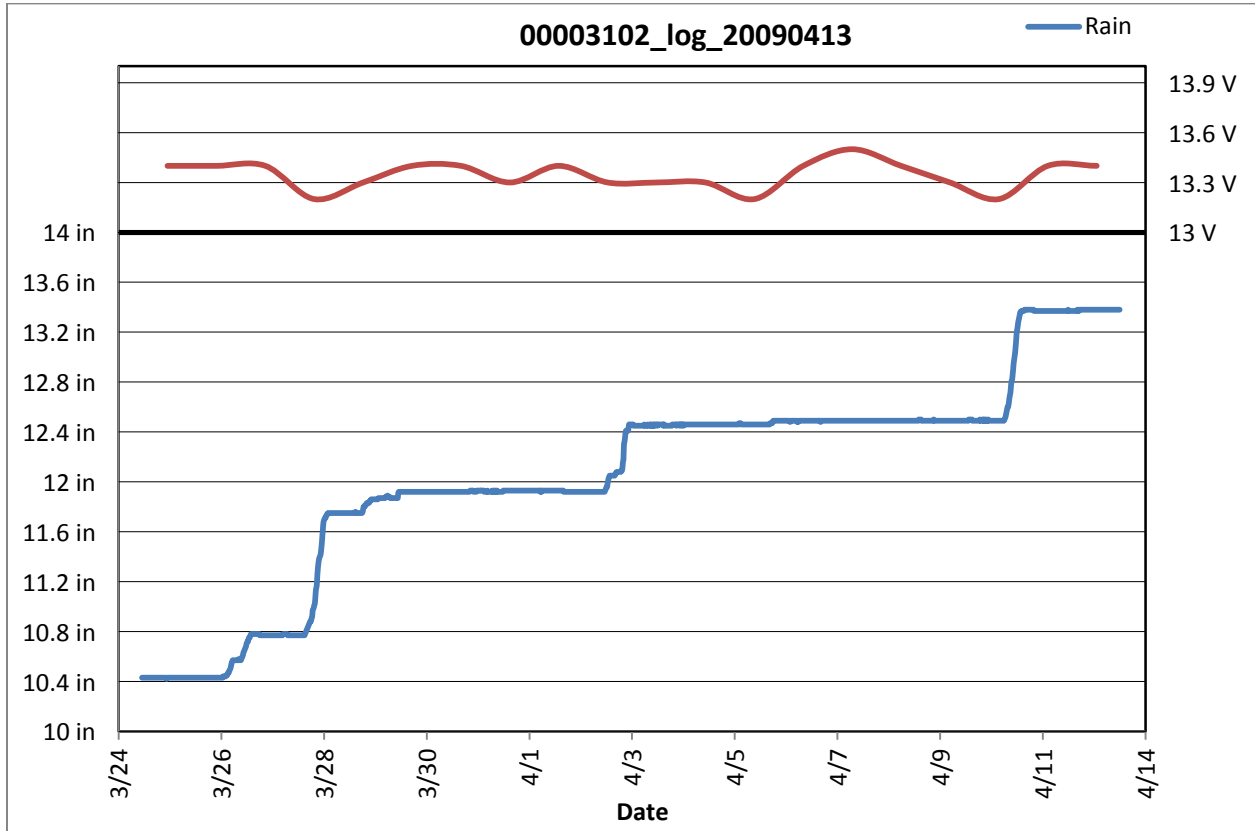

Figure A-9. FPR Plotting Macro Graphs Bucket Levels and Voltage

To obtain a copy of the *FPR-D Plotting Macro*, access the list of documents on, <https://www.ops1.nws.noaa.gov/Secure/COOP.html> and select **FPRD\_PlotData\_V1\_3.xls** .  
*Note: All of the COOP documents on this website were at one time on the original COOP Modernization website (i.e., <https://www.ops1.nws.noaa.gov/Secure/COOP.htm> ).*

Data outages can be a problem if the solar panel is not getting full sunlight for eight hours per day. The FPR-D gauge’s logger will produce flags in the data file when battery voltage levels drop below the level necessary to keep the logger on. The FPR-D is more prone to operator error than the FPR-E. Operator error can cause the system to drain power from the battery and can lead to outages in the precipitation record.

Note: For FPR-E (CES) gauges, select **FPRE\_PlotData\_V1\_3.xls**, (appears as *FPR-E Plotting Macro*) from the same password protected NWS website identified in the above paragraph.

1.3.7 Data Handling Cautions. Always when reviewing the contents of a monthly FPR data file, use the Windows *Notepad* program. When you close Notepad, ensure you **DO NOT** save the file.

Never open a file through Windows Explorer through a double click of the filename because this will open the CSV file immediately into an XLS format and thereby reformat the fields that comprise each 15-minute data record!

If you use FPR Plotting Macro, close and discard the plotted file! Never save the plotted file!

1.3.8 Submitting Monthly Files to NCEI. Between the 15<sup>th</sup> or 25<sup>th</sup> of month, you should have zipped together all FPR recording rain gauge precipitation data files, into a single ZIP file. Use the standard FTP application to upload your ZIP file to NCEI.

Regardless of the type of FPR equipment used, the Zip file that contains the individual sites' files is always named in this convention: **hpdkxxxMMyy.zip**. This file is the one NCEI ingests for processing. Where: kxxx identifies the WFO (i.e., kmeg for Memphis) and MM= is the data-month (i.e., 06), and yy= is the data-year (i.e., 13).

For detailed instructions see chapter two of the relevant *FPR Operations Manual*, use one of these links. Further questions should be addressed to HPD.NCDC@NOAA.GOV.

Click on the title of the manual, to access the, [FPR-D Operations Manual \(2015\)](#).

Click on the title of the manual, to access the, [FPR-E Operations Manual \(2015\)](#).

1.3.9. Records Retention Policy for FPR. Save the following data records and procedural documents to your WFO workstation.

- a. FPR generated precipitation data files for at least 12 months on the network workstation. Retain in original CSV file or TXT file format, never open these into XLS format or precipitation data will get corrupted.
- b. Any FPR Log Sheet, or any Datzilla Report, keep a printed or an electronic copy (i.e., optical scan of printed form) at WFO for 12 months.
- c. Bookmark: <https://www.ops1.nws.noaa.gov/Secure/COOP.html> for ready access to FPR manuals and FPR policy directives issued by NWS headquarters.

1.3.10 FPR Log Sheet Responsibility. The NWSREPs may delegate to certain observers the responsibility to drain and recharge the collection bucket. Provide these observers with an **FPR Log Sheet** (Similar to Fig A-11). Instruct them to complete the *FPR Log Sheet* anytime the bucket is emptied or when propylene glycol and oil are added, the weight of the collection bucket will change and produce a discontinuity in the Rain record.

Instruct your observer to Email or hard mail the *FPR Log Sheet* once per month to the WFO to your attention. The NWSREP may require the observer to report every month and if there are no maintenance actions conducted, to state so in the Special Notes section.

**FPR LOG SHEET**

Forecast Office (SID): TAE COOP Station Name: Pinetree State Park (01-5678) Your NWSREP Name: M. Jones

Date MM/DD/YYYY	Time hh:mm am/pm	Amount NN.cc	Routine Actions	Special Notes (i.e., displayed error messages, etc.)
<u>09/28/2011</u>	Start: <u>10:15 am</u> Stop: <u>10:45 am</u>	<u>15.47</u> <u>02.75</u>	<input type="checkbox"/> Add Oil <input type="checkbox"/> Add FGPG <input type="checkbox"/> Empty Bucket <input checked="" type="checkbox"/> Partial Drain Funnel - <input checked="" type="checkbox"/> In <input type="checkbox"/> Out	
<u>06/14/2011</u>	Start: <u>4:15 pm</u> Stop: <u>4:45 pm</u>	<u>8.72</u> <u>8.72</u>	<input type="checkbox"/> Add Oil <input type="checkbox"/> Add FGPG <input type="checkbox"/> Empty Bucket <input type="checkbox"/> Partial Drain Funnel - <input type="checkbox"/> In <input type="checkbox"/> Out	'Err 12' message displayed. Phoned NWSREP.
<u>09/28/2011</u>	Start: <u>2:30 am</u> Stop: <u>2:45 am</u>	<u>10.39</u> <u>10.39</u>	<input type="checkbox"/> Add Oil <input type="checkbox"/> Add FGPG <input type="checkbox"/> Empty Bucket <input type="checkbox"/> Partial Drain Funnel - <input type="checkbox"/> In <input checked="" type="checkbox"/> Out	Wiped down the F&P shell to remove dust.
<u>10/15/2011</u>	Stop: <u>11:15 am</u> Stop: <u>12:15 pm</u>	<u>14.35</u> <u>0.75</u>	<input checked="" type="checkbox"/> Add Oil <input type="checkbox"/> Add FGPG <input checked="" type="checkbox"/> Empty Bucket <input type="checkbox"/> Partial Drain Funnel - <input type="checkbox"/> In <input type="checkbox"/> Out	Removed pinecone, cleaned bucket, and then added 1-qt of oil.
<u>12/21/2011</u>	Start: <u>9:30 am</u> Stop: <u>9:30 am</u>	<u>6.14</u> <u>6.43</u>	<input type="checkbox"/> Add Oil <input checked="" type="checkbox"/> Add FGPG <input type="checkbox"/> Empty Bucket <input type="checkbox"/> Partial Drain Funnel - <input type="checkbox"/> In <input type="checkbox"/> Out	Very cold month – had to add 2 quarts of FGPG to prevent ice damage.

**Instructions:** Before you start your action, enter the date and then at time of maintenance, enter current time (standard time, not daylight time) on the 'Start' line in Column 2. Then press the Display button to view the Amount in bucket. Write this value in Column 3 (Amount). Then mark appropriate box(es) in Column 4 (Routine Actions) to indicate your actions. If not a routine action, write your comments in Column 5 (Special Notes). When you have completed your action, go back to Column 2, and enter current time (standard time, only) into the 'Stop' line. Always phone your NWSREP if an error message displays or display fails to light-up on command. Always mail your Log Sheets to your NWSREP. Keep spare sheets inside shelter.

Figure A-10. FPR Log Sheet (NWSREP provides to Observers)

1.4 Fischer-Porter Mechanical Recording Gauge (Punch Tape). The mechanical gauge punches holes in a paper tape on a moving scroll every 15 minutes. Although the punch tape is designed for automatic machine processing, it may be read visually by summing the values of the holes punched. Punches are made for the following values: 0.1, 0.2, 0.4, 0.8, 1.0, 2.0, 4.0, 8.0, and 10.0 inches. For a precipitation amount of 3.7 inches, the following punches would be made: 2.0, 1.0, 0.4, 0.2 and 0.1 inches, the sum of which equals 3.7 inches.

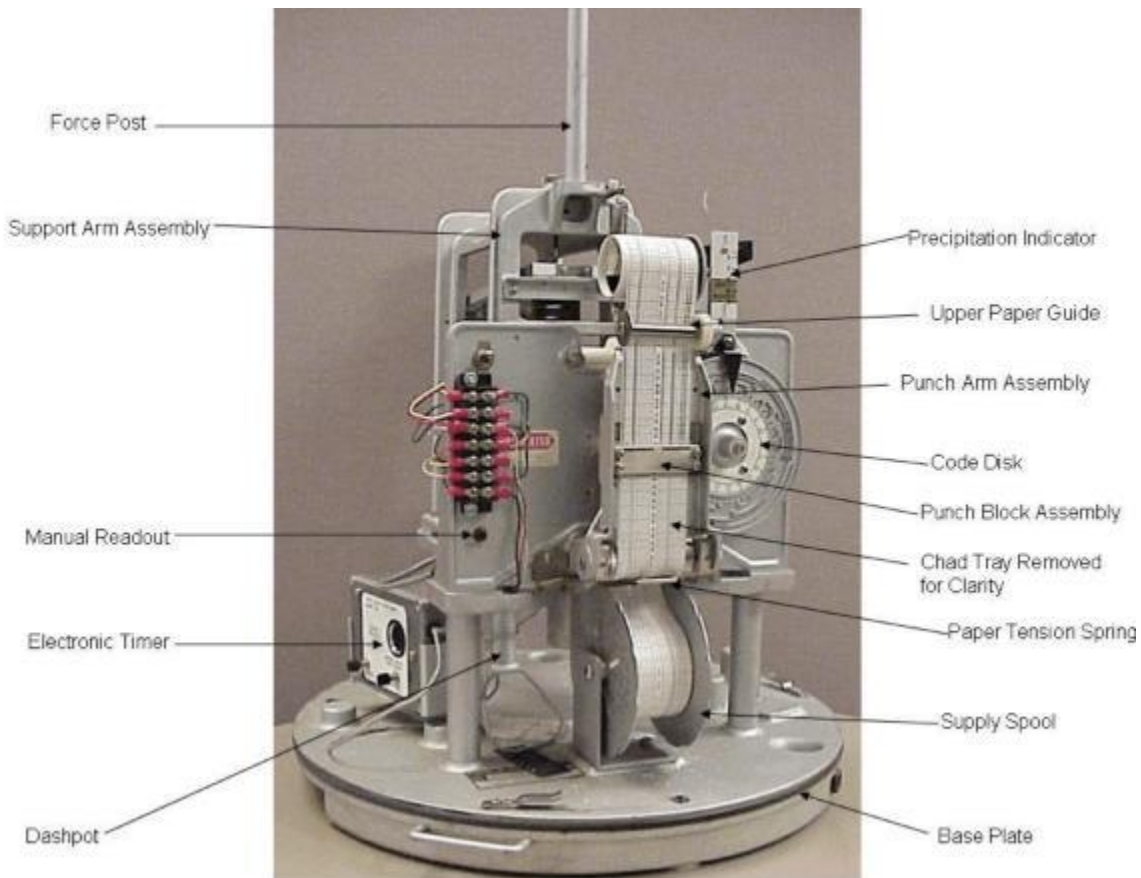

Figure A-11. Recorder Components of Fischer-Porter Mechanical Gauge – Casing Removed

An illustrated instruction bulletin is provided with each instrument. It should be consulted for details on any specified model. The Fischer-Porter mechanical gauge is powered by a 6 volt DC battery. The battery is recharged in the field by a solar panel. The measuring device consists of:

- a. a collection bucket for captured precipitation,
- b. a weighing device, and
- c. an indicator dial showing the amount of precipitation collected

1.4.1 Setting the Tape to the Correct Time. The electronic timer (Figure A-11) will trigger the gauge to punch every 15 minutes. Ensure the power switch is set “ON.” The best time to change the tape is immediately after a routine punch. This will allow 15 minutes to change the tape without missing any readings. The Model III timer has two buttons and a window on the front face. The window allows the observer to see the LED timer. The right button is pressed to light the LED while the left button is pressed to advance the time. The timer should be set to the number of minutes past the last scheduled punch time.

Set the tape to the correct time, as follows:

- a. With the power switch “OFF,” feed the tape through the punch block onto the take-up spool. Continue feeding the tape until the first time line to appear above the punch block reads two hours before the current time. (See Figure A-12).
- b. Turn the power switch to the “ON” position and push the button to advance the tape eight punches or until the time line on the tape corresponding to the next 15-minute time interval is lined up with the holes in the punch block. Next, draw a line across the tape just above the punching block, using a felt tip pen. Write the date and time on the tape above the punch block. This reference will determine the actual start of the record. The next punch should occur at the next 15-minute clock interval and it should agree with the time shown by the tape within 15 minutes. Hold the button down 5 seconds for each punch.

1.4.2 Operation and Maintenance for Punch Tape. The NWSREP is responsible for installation of the gauge, and training the cooperative observer on its operation and simple maintenance, for example the removal and replacement of paper tape. The observer should be instructed to do each of the nine major tasks listed in Section 2.5.4, *Fischer-Porter Mechanical Gauge Upkeep and Reporting*, found in Appendix B of this document.

1.5. Fischer-Porter Maintenance Schedule. Plan seasonal maintenance in advance with your COOP observer. Some NWSREPs delegate basic bucket emptying and recharging to the COOP observer.

The following actions should be taken during the year:

- a. Empty or drain the bucket before the level reaches 15 inches. Follow the management of waste procedures in NWSM 50-5116 Section 2 (2.11.2b).
- b. Provide the Observer printed instructions, if bucket maintenance is delegated.
- c. Check the calibration of the weighing sensor.
- d. Supply the Observer with food grade propylene glycol (will be referred to as propylene glycol or PG) and/or oil or other supplies as required.

**SEMIANNUAL CHECK FOR ALL MODELS OF FISCHER-PORTER RAIN GAUGE:**

What to Check	How to Check	Precautions and Remarks
1. Overall Appearance	Observe paint finish, or evidence of vandalism.	Clean oil film from the outside of gauge using nonflammable liquid detergent.
2. Weather Stripping around Base Plate and Access Door.	Check for breaks or general deterioration. Weather stripping is used around Base Plate (ASN part D111-1MS100).	Replace as needed the weather stripping or door gasket. Cut base plate weather stripping to about 50 inches.
3. Horizontal and Vertical Flexures in the Weighing Mechanism.	A quick glance will reveal the condition of the four horizontal flexures. If any are bent, broken, or binding it might affect gauge calibration. Ensure you replace any horizontal flexures which are ‘v-shaped.’ The upper-rear flexure (ASN part D111-SP112) is most susceptible to bending.	Use the smallest test weight of the D111-500TE set to ensure the Precipitation display shows a change in current values. If it does not change, the flexure(s) should be replaced.
4. Funnel	Use the funnel in warm season. Remove funnel for winter season when snow or freezing precipitation is expected.	On the <i>FPR Log Sheet</i> check boxes, ‘Funnel-Out’. Reinstall funnel after winter season then check, ‘Funnel- In.’
5. Charging Collection Bucket – Warm Season Operation.	Collection bucket is charged for warm season by adding one-half quart of oil (ASN part, ‘014-O-15’); to retard evaporation.	Before charging bucket, remove any foreign material and clean the interior surface.

<p>6. Charging Collection Bucket – Cold Season Operation.</p>	<p>When collection bucket is charged for winter weather, add two quarts of PG, (ASN part # D111-153) then add one half-quart of oil. For exact amount see Table A-3.</p>	<p>For colder climate sites where temperatures drop to 15°F and colder, more PG needs to be added when collected rain and melted snow dilutes the PG concentration. Refer to Table A-3, for the number of quarts to add as the bucket level rises.</p>
<p>7. Draining or Emptying the Collection Bucket</p>	<p>The collection bucket is drained when the display indicates <b>15 inches or more</b>. On the legacy gauge, this occurs when dial is 5 inches past one full revolution.</p> <p>See NWSM 50-5116, section 2.11.1, for rules on disposal. The used-oil contractor will usually accept this oil-propylene glycol mixture.</p> <p>Ensure the Observer has one printed copy of the Material Safety Data Sheet (MSDS) for the Oil. The MSDS can be printed from the CLS parts ordering website.</p> <p>See NWSM 50-5116, section 2.11.1, for rules on disposal. The used-oil contractor will usually accept this oil-propylene glycol mixture.</p>	<p>Revise <i>FPR Log Sheet</i> by marking box ‘Add PG’ and if oil was added, ‘mark the box ‘Add Oil.’</p> <p>For FPR-D gauge, before you start any action, press the key pad to have the logger create a record in the data file.</p> <p>Mark the <i>FPR Log Sheet</i>, ‘Bucket emptied’ or ‘Partial Drained’ if cleaned, write in notes section: ‘Cleaned Bucket’.</p> <p>When you have completed all bucket re-charging actions write the new value of the precipitation display (or dial reading) to <i>FPR Log Sheet</i>.</p>

Table A-2. Semi-Annual Check – For All Models of the Fischer-Porter Gauge

1.5.1 Inspect Exterior Surfaces and Routine Cleaning. Periodic inspection of hardware is a best practice that will help ensure good system performance and quality representation of precipitation data. Ensure there are no obstructions that block the aperture of the gauge bucket and that all access doors and their hinges, latches, and locks, are working properly. After clearing obstructions, use a damp cloth or paper towel with gloves to wipe clean exterior surfaces.

- a. Upper Housing, Funnel and Bucket: each free and clear of debris.
- b. Access Doors, hinges, latch, and lock: all should be functional.
- c. Solar Panel: ensure it is fastened tight, free and clear of debris. Ensure the cable and cable plugs are properly positioned and appear in good condition. Ensure solar panel is not covered by dust, bird droppings, snow, or obstructed by any shaded objects.



Figure A-12. Fischer- Porter Recording Rain Gauge

1.5.2 Bucket Draining. The empty bucket has the capacity for 22 inches of rainfall (or 4.9 gallons). Instruct the Observer to read the gauge display weekly during rainy periods, to anticipate the date to drain the bucket. When the Observer reports the display reading exceeds 15.00 inches, drain the bucket. If the Observer was delegated the task of draining the bucket, also have the observer journal the date of draining and the bucket level amount into the *FPR Log Sheet* (Figure A-10). Follow instructions outlined in paragraph 1.3.10, and enter to Log Sheet whether you have completely emptied the bucket, or have partially drained the bucket and how you recharged the bucket. Turn to Section 1.3.10 for instructions on entries to *FPR Log Sheet*.

1.5.3 Summer Maintenance. Remove the cone-shaped hood and inspect the contents of the bucket with a mixing stick (i.e., paint stirrer). Remove and properly dispose of any leaves or debris that might have collected when the funnel was removed at start of winter season. Then with the stick, ensure there is still a ¼ inch film of oil on the surface to inhibit evaporation. Drain the bucket until the fluids are one inch from the bottom and so keep the oil from running out the drain tube. Drain the contents into a container with 5-gallon capacity. The fluids can be safely disposed to a sanitary sewer system. Then install the funnel to the underside of the hood.



Install the funnel: Remove the conical housing, turn it upside down, and fasten the funnel by rotating its three slots onto the three pins of the cone shaped hood. Return this hood assembly to the gauge.

1.5.4 Winter Maintenance. During the season when frozen precipitation or freezing temperatures are likely to occur; recording gauges need to be winterized, as described below:

- a. Remove funnel: Remove the cone-shaped hood tip it upside down and set it down. Rotate the funnel so its slots allow it to slide free from the three pins located on the base of the hood assembly.
- b. Empty the collection bucket by unhooking the top end of the drain tube and placing the end into a multi- gallon container. **Caution:** Do not attempt to lift a full bucket by yourself, because it can weigh 40 pounds.
- c. Return the empty bucket to its regular position to ready the bucket for its charge of propylene glycol. Following the propylene glycol you will add one half quart of oil. Do not use commercial anti-freeze or add water.
- d. Initial charge: Into the empty bucket, pour an amount of food grade propylene glycol as specified by one of the three temperature categories listed in this table. Choose the category that offers protection against the coldest condition possible for the site. Make an initial charge of 1.0 quart of propylene glycol if the coldest the site could get is 15°F.

Coldest Temperature	Initial charge and subsequent charges of food grade propylene glycol (PG). When display reaches 3.5-inches, 7.0-inches, 10.5-inches, or 14.0-inches, add this amount of PG.	To Maintain this Concentration
+ 15° F	1.0 quart	25%
0° F	1.5 quarts	35%
- 30° F	2.0 quarts	50%

Table A-3. Propylene Glycol Schedule for Extreme Cold Sites

Note: Two quarts of propylene glycol increase height of liquid by just one inch.

- e. Subsequent Charges: When visual inspection of display shows the bucket level has reached 3.5 inches add the specified amount of propylene glycol; for example the coldest category sites (- 30°F) require two quarts be added. Always add the same amount as the initial charge. If you had not serviced the bucket at either 3.5 inches, or 7.0 inches, or 10.5 inches and now notice the bucket holds 11 inches, take action to drain the bucket. Recharge the empty bucket with at least two quarts of propylene to ensure the first 3.5 inches of precipitation (liquid equivalent) has 50% concentration. To prevent the bucket contents from ever

freezing, add propylene glycol per the schedule in the above table at 3.5, 7.0, 10.5, and 14.0 inches.

- f. Add a half a quart of oil after the initial charge of propylene glycol. For sites more prone to evaporation, these include tropical sites and sites with windy conditions with low relative humidity; ensure a film of oil is visible after draining water/propylene glycol mixture. Use NWS supplies, only.

Further Considerations: If bucket is emptied of all contents, then charge with one half quart of oil. You do not need more than  $\frac{1}{4}$  inch surface oil layer in the Fischer Porter's 14 inch diameter bucket. Snowfall and high-rate rainfall events can lead to a layer of snow, ice, or fresh rainwater that rests on top of the oil layer. For these events stir the bucket with a mixing stick. This will prevent freezing and possible equipment damage.

- g. Make no adjustments to the gauge after propylene glycol and/or oil has been added.
- h. Document the date and hour each time the bucket was charged with propylene glycol and/or oil. For legacy gauges mark the paper tape with a brief note (i.e., added propylene glycol and/or oil at 2PM March 16, 2010). Make an entry to the *FPR Log Sheet*, according to Section 1.3.10, and Figure A-10.

## 2. AIR TEMPERATURE INSTRUMENTATION

2.1 Introduction. The NWS Cooperative Observer Program requires three temperature observations to be recorded once per day. They are the maximum air temperature, the minimum air temperature and the air temperature at the time of observation. All three readings are taken at a standard time on the hour the Observer has agreed to routinely take the daily observation (i.e., 7am). Temperature readings are taken from the digital display of a sheltered electronic thermometer (Fig A-14) or from sheltered liquid-in-glass thermometers (Fig A-15).

The minimum air temperature is the lowest numerical value to have occurred on the electronic thermometer since it was last read and reset. Similarly, for the liquid in glass, this is the lowest numerical level since the minimum thermometer was last read and reset.

The maximum air temperature is the highest air temperature to have occurred on the electronic thermometer since it was last read and reset. Similarly, for the liquid in glass, this is the highest numerical level since the maximum thermometer was last read and reset.

The temperature at the time of observation is the temperature on display at the time the electronic thermometer is read. For the liquid in glass thermometer, the temperature at the time of observation is the one acquired from the minimum thermometer from the reading of the amber column when it is in the nearly horizontal position.

For requirements and standards for the air temperature observation, see Section 4, NWSI 10-1302, *Requirements and Standards for NWS Climate Observations*.

2.2. Siting Requirements. Optimally the sheltered thermometer should be at least 100 feet from any paved or concrete surface. Under no circumstances should a shelter be placed near the outflow of a heating or air-conditioning unit. Nor should the sheltered thermometer be placed where parked or moving vehicles could influence the thermometer.

When possible, the shelter should be no closer than four times the estimated height of any obstruction (tree, fence, building, etc.). The exposure should represent the ambient air temperature and natural airflow should be unimpeded to give a representative measurement of the larger environment. Siting requirements are given in NWSI 10-1302, Section 3, *Requirements and Standards for NWS Climate Observations*.

2.3 Shelter Requirements and Maintenance. Thermometers are enclosed in a radiation shelter to reduce the risk of erroneous readings. This way, sensors are shielded from sun, rain, snow, and non-natural sources of light, heat, or cold. Shelters are designed to allow the maximum possible free flow of air. Ventilation is accomplished by louvers which slope downward from the inside to the outside of the shelter and with a double top.

Figure A-13 (foreground) shows the standard Cotton Region Shelter (CRS) used most often for liquid-in-glass maximum and minimum thermometers. Liquid-in-glass thermometers are mounted on a horizontal board located in the upper middle part of the shelter.

The MMTS shelters are shown behind the CRS in Figure A-13.

A level, open clearing is desirable so the thermometers are freely ventilated by the flow of air. The ground under the shelter should be typical of the surrounding area. Do not install on a steep slope or in a sheltered hollow unless it is typical of the area, or unless data from that type of topographic location is desired.

All shelter supports or poles should be mounted securely enough into the earth or a concrete slab to eliminate vibrations. Strong winds can cause vibrations that will displace the indices on the liquid-in-glass maximum and minimum thermometers, causing erroneous readings. Ensure the wooden shelter door faces “north” to prevent the sun from shining on the thermometers when the door is open.

Dust the inside of the CRS occasionally with a dry cloth. Inspect supports for a secure mounting. As the NWSREP you are responsible for painting the CRS when needed.



Figure A-13. Instrument Shelters: Cotton Region Shelter and Two MMTS Shelters

**Caution:** If you have a CRS with painted surfaces in poor condition, with chips missing or paint peeling and flaking, then first determine if this CRS shelter might be of the older design with a layer of lead-paint. Do not sand or wipe down a CRS that is suspected of having lead-paint. Phone the Sterling Field Support Center, 703-661-1268, or email them at [nws.sfsc@noaa.gov](mailto:nws.sfsc@noaa.gov) to ask if you need to submit a sample of white paint from the CRS shelter for official testing of lead-paint content.

Remove insect nests and other matter restricting air flow through the MMTS shelter (Figure A-14) when needed. As NWSREP you should periodically disassemble the MMTS shelter and clean the plastic louvers with mild soap and water. The sensor should be cleaned with a non-abrasive cloth. Reassemble the plastic louvers in the same location before it was disassembled. Not all the plastic louvers are the same size.



Figure A-14. MMTS Shelter

**Caution:** Plastic louvers have sharp edges that may cause injury.

2.4. Types of Thermometers. There are two types of temperature sensors approved for use at the cooperative stations: liquid-in-glass maximum and minimum thermometers and several models of electronic thermometers. Figure A-15 shows the liquid-in-glass (LIG) maximum and minimum thermometers in their ordinary observing position. The LIG thermometers are required to be housed within a cotton region shelter (CRS). The CRS is featured in Figure A-13.

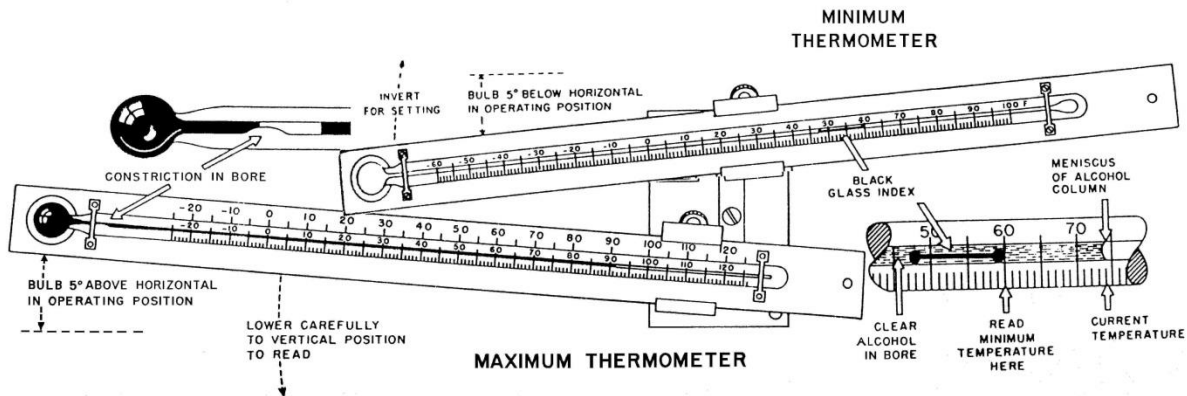

Figure A-15. Minimum Thermometer and Maximum Thermometer in Position

2.4.1 Liquid-in-Glass Maximum/Minimum Thermometers.

2.4.1.1 Maximum Thermometer - How It Works. The maximum thermometer has a mercury-filled bulb sensing element. It is exposed in a nearly horizontal position (Figure A-15). Graduations at one degree intervals are etched on the stem. The bore is constricted between the graduated portion of the stem and the bulb, as shown in Figure A-16.

As the temperature rises, some of the expanding mercury in the bulb is forced to pass through the constricted portion into the graduated portion. As soon as the temperature falls, the column of mercury breaks at the constriction leaving the thread of mercury in the graduated portion indicating its highest reading.

The thermometer is turned vertical for reading. The top of the mercury column indicates the highest temperature reached. Once the maximum temperature is read, the max thermometer is spun in its mount to force the mercury in the graduated tube past the constriction until it joins the mercury in the bulb. When joined, the maximum thermometer will indicate the current air temperature. Take care not to touch the glass bulb, or let your body heat come near the bulb or you will need to reset the thermometer with another spin. Instructions for resetting the Maximum Thermometer are found in Appendix B, Section 3.2.2.

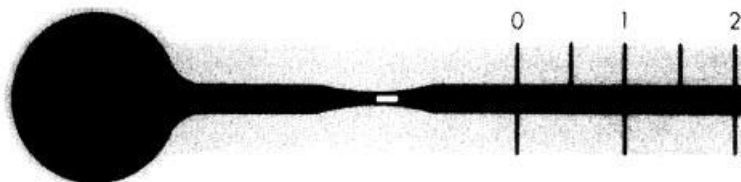

Figure A-16. Maximum Thermometer (Contains Mercury)

2.4.1.2 Minimum Thermometer - How It Works. The minimum thermometer has a spirit-filled bulb, graduated at one degree intervals, and exposed as shown in Figure A-17. The spirit is often colored to make it easier to read. The bore contains a dark dumbbell-shaped object called an index (Figure A-17). As the temperature rises, the spirit expands and flows around the index without displacing it. Also instruct the Observer to use this thermometer to measure the ‘At-Observation’ temperature. Instructions for resetting the Minimum Thermometer are found in Appendix B, Section 3.2.1.

Part (a) of Figure A-17 shows the top of the spirit column some distance to the right of the index.

In Part (b), the spirit column has retreated with falling temperatures until the top just touches the index.

Further cooling moves the index nearer the bulb (to the left).

As the temperature rises again, the spirit column moves toward the right without moving the index.

Part (c) in Fig A-17 shows an incorrect reading with the index trapped in the broken spirit column.

Instruction to correct this problem is given in Appendix B, Section 2.4.2, of this manual.

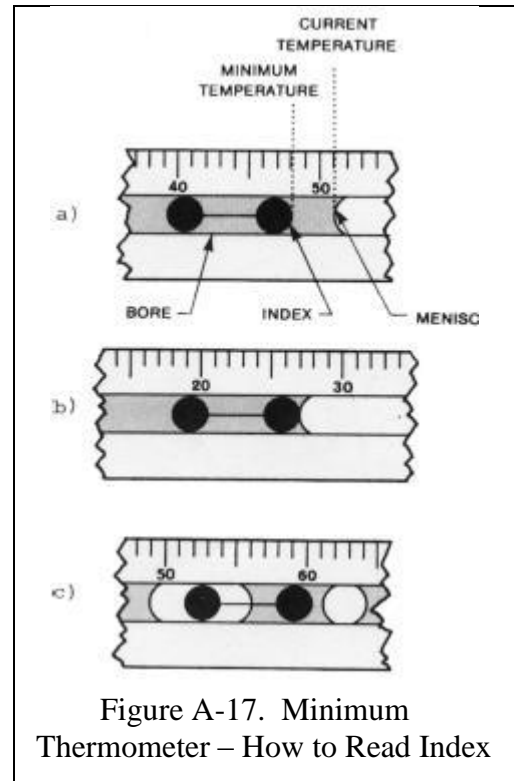

2.4.1.3. Mounting and Maintaining the Thermometer Support. Thermometers are mounted in instrument shelters on supports such as the one shown in Figure A-18. This support is known as the “Townsend Support.” The support makes it easy to read and reset the thermometers to the current temperature at the time of observation.

The support consists of two metal shafts fastened to a metal base plate. Clamps, which hold the thermometers, are attached to the end of the shafts. The longer shaft holds the maximum thermometer, while the shorter shaft holds the minimum thermometer. The maximum thermometer may be spun (rotated) by hand to reset the mercury column to the current temperature. A pin in the minimum thermometer shaft prevents it from rotating more than a quarter turn (about 90°). It is reset by rotating it to the vertical position.

- a. Clamp the metal back of the **maximum thermometer** to the lower (longer) shaft

of the support at a point 3.5 inches from the high-temperature end of the back. The bulb end will be to the left, and raised about 5° angle above horizontal. This is its normal operating position for the 24-hour period of measuring (Fig A-15).

- b. Clamp the metal back of the **minimum thermometer** to the upper (shorter) shaft. The back should be clamped at a point slightly closer to the high temperature end than the bulb end. The bulb end should be to the left when the thermometer is set.
  
- c. The bulbs should not touch any object when rotated or tilted vertically. When properly installed and set, the bulb end of the minimum thermometer will be about 5° below the horizontal, for its normal operating position (Figure A-15).

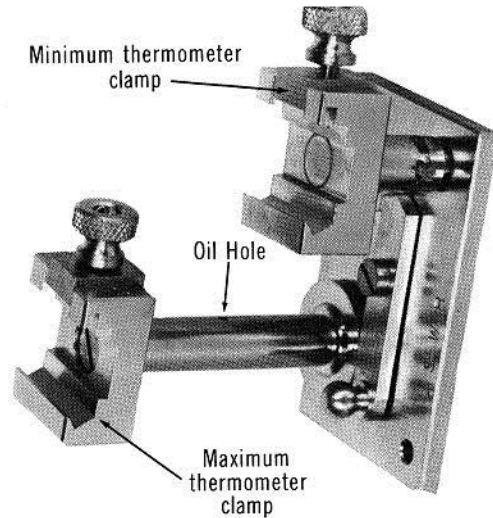

Figure A-18. Townsend Support for Maximum/Minimum Thermometers

2.4.1.4 Mercury Clean-Up. Each cooperative observing site with mercurial thermometers should have one mercury clean-up kit for each mercury thermometer and a one printed Material Safety Data Sheet (MSDS).

Clean-up kits may be purchased either by the Weather Forecast Office or by the Regional Headquarters. Two examples are: Safetec EZ Cleans Mercury Spill Kit; and LAB SAFETY SUPPLY ® Portable Mercury Spill Kit.

The kit should include a pair of gloves (rubber, polyethylene or polyvinylchloride), safety glasses, mercury absorbent sponge/sponges (e.g., Hg Absorb), mercury absorb powder, magic marker, adhesive tape (e.g., duct tape), adhesive label, and a self-sealable heavy duty plastic bag.

The NWSREP is responsible for training each cooperative observer on how to clean-up a mercury spill from a broken thermometer. If a mercurial thermometer breaks, there could be pieces of mercury contaminated glass and droplets of mercury on the floor of the CRS. Instruct the observer to follow instructions provided with the clean-up kit. A list of basic instructions is found in Appendix B, Section 2.5, Mercury Clean-Up.

The NWSREP is also responsible for transportation and disposal of the mercury waste according to instructions in [NWSM 50-5116, \*Environmental Management\*](#), Chapters 2 and 3.

2.4.2 Electronic Thermometers. The electronic thermometer measures the current air temperature over a range from  $-55^{\circ}\text{F}$  to  $+130^{\circ}\text{F}$  and compares it to the highest and lowest values stored in the memory. If the current temperature exceeds the previous highest or lowest reading, then it becomes the newest maximum or minimum temperature.

The electronic portion of the instrument is called a temperature display unit (TDU) and NWS is currently using three models as shown below in Figures A-19, A-20, and A-21. The TDU is installed indoors and is connected by wire to the thermometer sensor, mounted outdoors. All three NWS TDU models use the same thermistor as their temperature sensor. The TDU is matched to the response of that particular thermistor type and other thermistors cannot be substituted without approval from NWS HQ.

All new and upgrade TDUs are to be installed with a lightning/surge protector called the primary protector assembly (PPA). The PPA is mounted outdoors, in the sensor line between the thermistor shelter and the TDU. The PPA is installed according to COOP Modification Note, [Primary Surge Protector ASN C460-6 Logistics Replacement](#), posted to the “Temperature” observations portion of the NWS internal website.

Lightning/ surge protection requires the use of a good facility ground rod, and if the observer’s facility does not have an adequate grounding electrode conductor, then the OPL/DAPM is required to permanently remove the MMTS or Nimbus system from this COOP site.

2.4.2.1 Initial Checkout of Instrument. The NWS has three types of approved electronic display units, the MMTS-1, the MMTS-7, and the Nimbus PL-2. The Nimbus model will replace the MMTS models only as needed at observer site where the MMTS display unit is confirmed broken. **Note: There are relatively few MMTS-7 units left in service; approximately 150.**



Figure A-19. MMTS-1  
Original



Figure A-20. MMTS-7  
Upgrade



Figure A-21. Nimbus  
Display Unit

**Important:** Always turn the electronic display unit power switch “off” on the MMTS units when they are not plugged in. If the power switch is “on” and the unit is unplugged, the battery supplying the emergency backup power will severely discharge, “permanently damaging” the system. The Nimbus does not have an on/off switch. When not in use, remove the AC adapter and the 9-Volt battery to power down the unit.



**Instructions for the Installation and Checkout of the MMTS and Nimbus Thermometers:**

**NIMBUS Display Unit - Installation Procedure**

1. Connect cable from shelter to NIMBUS display unit.
2. Install 9-Volt alkaline battery into display unit.
3. Plug-in AC adaptor into wall outlet and then into display unit.
4. Unit is always “on” if the battery is good and the AC adapter is connected.
5. Depress and hold ‘**CLEAR**’ button until the display reads ‘**E2E2.**’ This takes about six seconds. Then release button. The unit will display current temperature.
6. A bad cable or open or shorted sensor will show ‘**-99.9**’ or ‘**255.5**’ on the **Nimbus** display. Less likely this may indicate temperatures colder than -55°F or hotter than 125°F

Table A-4. Installation and Check-out of Nimbus Display Units

**MMTS Display Unit – Installation Procedure**

1. Connect cable from shelter to MMTS display unit.
2. Plug the display unit’s AC power cord into outlet.
3. Turn on Power Switch on rear panel of Display Unit.
4. Look for the Display Unit’s status message “**HELP**”

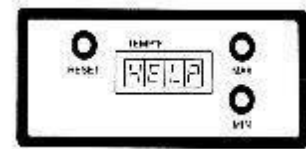

MMTS ‘Help’ Display

This message indicates the system is functioning properly.

5. Display the current temperature. Depress the **RESET** button and this will replace the ‘HELP’ reading with current temperature in tenths of a degree Fahrenheit.
6. A bad cable or shorted sensor will show as “**LO**” or “**HI**” on the **MMTS** display. Less likely, this may indicate temperatures colder than -55°F, or hotter than 125°F.

Table A-5. Installation and Check-out of MMTS Display Units

2.4.2.2 Calibration. No calibration is necessary due to the design of the temperature sensor. To verify proper operation, some cooperative observers may be given accuracy verification equipment by the NWSREP, who will provide instructions on its use. The temperature sensor used with all three display units is accurate within  $\pm 0.4^{\circ}\text{F}$  between  $-40^{\circ}\text{F}$  and  $+104^{\circ}\text{F}$ , and within  $\pm 0.7^{\circ}\text{F}$  for temperatures between  $-40^{\circ}\text{F}$  and  $-55^{\circ}\text{F}$  and between  $+104^{\circ}\text{F}$  and  $125^{\circ}\text{F}$  if working properly.

2.4.2.3 Nimbus Susceptibility. If a Nimbus TDU is located in proximity to a nearby radio transmitter, the observer may notice periodic spurious data. If this is reported, an MMTS should be used to replace the Nimbus and resolve the problem.

### 3. PAN WATER EVAPORATION INSTRUMENTATION

3.1. Introduction. Observations of the amount of evaporation from an open pan are made to the nearest hundredth of an inch. Other elements recorded include wind movement, water and air temperatures, and precipitation. At some sites, additional parameters will be required, such as dry- and wet-bulb temperatures, humidity, and the temperature and moisture content of the soil. Instructions on pan water evaporation measurements are found in Section 3, of Appendix B.

Evaporation measurements are made with an evaporation pan and a fixed-point gauge with a measuring tube.

Evaporation stations have the following additional instruments:

- a. A totalizing anemometer (with counter) to determine the daily wind movement over the pan (Section 3.5).
- b. A non-recording precipitation gauge with appropriate measuring stick or in some cases, a weighing-type recording precipitation gauge.
- c. A water temperature thermometer to provide maximum, minimum, and current temperatures of the water in the evaporation pan (Section 3.6).
- d. Maximum and minimum thermometers for measuring the air temperature. An MMTS system can also be used.
- e. An instrument shelter for housing the thermometer(s) that measure maximum and minimum temperatures, if not electronic.
- f. A garden hose connected to a water supply, or a water storage tank if necessary, to provide a reserve water supply for the pan.

#### 3.2. Setting up the Observation Site.

3.2.1 Exposure of Equipment. The equipment site should be fairly level and free of obstructions or influences that would affect evaporation. It should be representative of the principal natural agricultural soils and conditions (i.e., flora) of the area.

Neither the pan nor instrument shelter should be placed over heat-absorbing surfaces such as asphalt, crushed rock, concrete slabs or pedestals. The equipment should be in full sunlight during as much of the daylight hours as possible, and be generally free of obstructions to wind flow. Obstructions that cannot be moved, such as trees, buildings, and nearby shrubs, should not be closer to the instruments than four times their heights. Shadows are permissible only near sunrise and sunset. Avoid areas subject to flooding or lawn sprinkling.

At reservoirs (flood control, water supply, and irrigation projects) the pan should be placed on the prevailing upwind side of the water. The pan site should be far enough from the water to

avoid the chance of water or spray carried from a spillway, or picked up from the reservoir by a strong wind that will be deposited in the pan.

3.2.2 Plot Layout. The layout of the equipment on an example plot is shown in Figure A-22. The orientation of the layout is indicated by the position of the CRS and its door facing north.

Note the layout is designed to eliminate shadows from instruments at stations in the northern hemisphere. Shadows from small diameter fence posts will occur only briefly in the late afternoon. The minimum distances between instruments are illustrated.

The 16 by 20 foot plot shown allows ample room for more equipment. The size of the plot can be either smaller or larger depending on how much equipment is needed.

3.2.3 Enclosure. Enclose the plot by a fence to keep out animals. A steel chain link fence (9 or 11 gauge), 4 or 5 feet high, with steel posts set in concrete is recommended. Fences of wood or other solid material will not be used. Burying a barrier underneath the fence may be necessary for protection from burrowing animals, or add 18 to 24 inches of one inch galvanized chicken mesh fence along the bottom of the chain link fence to keep out small animals.

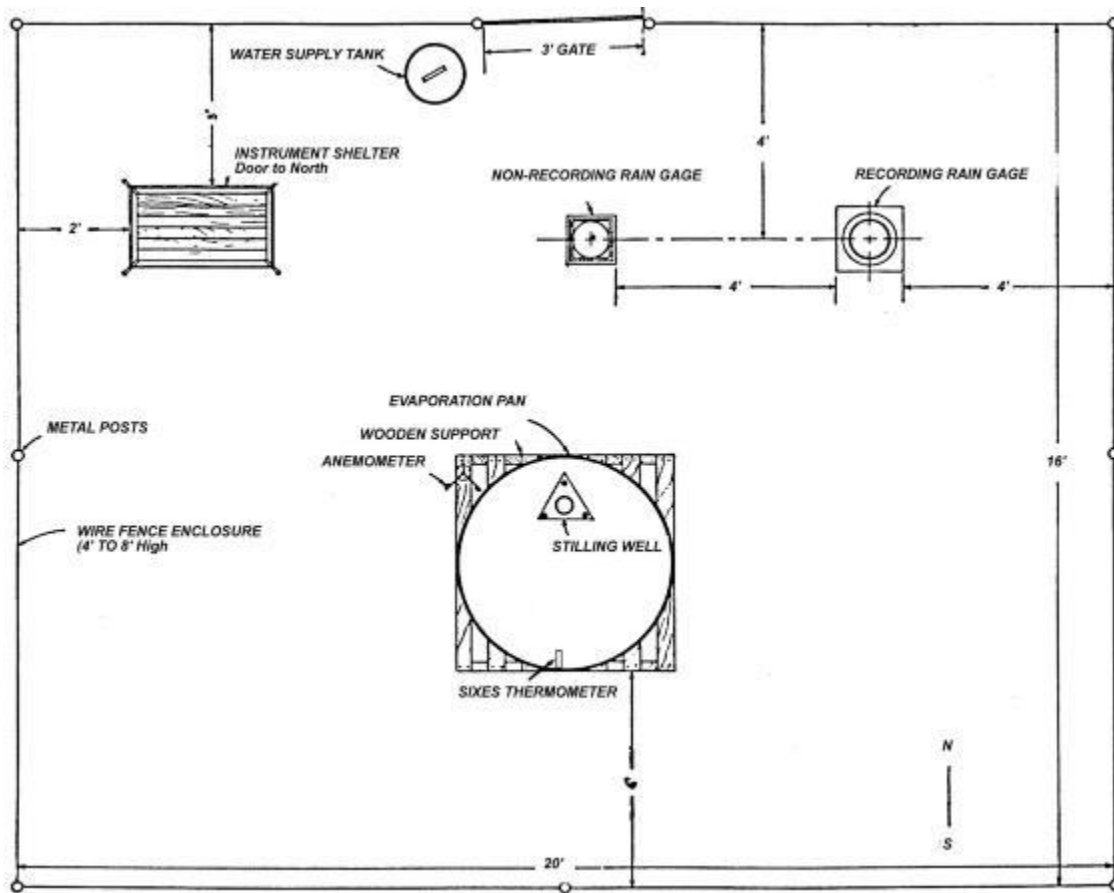

Figure A-22. Evaporation Station Plot Layout Example

3.3. Evaporation Pan. The pan is circular, 10 inches deep, and has an inside diameter of 47.5 inches. It is constructed of stainless steel. In its operational configuration, the evaporation pan (Figure A-23) contains a mass of water, a stilling well, and a submerged thermometer. Stations are configured with a totalizing anemometer mounted on the wooden pan support.

3.3.1 Installation. Center the pan on a pressure treated wooden support resting on leveled ground in order to assure there is level water in the pan. Ensure that the pan is located in an area free from flooding even in heavy rains, or where runoff could wash away the support. If fill dirt is required to level the ground, it should be tamped firmly. The top of the wooden support should be a minimum one-half inch above the dirt. This will leave an air space between the bottom of the pan and the fill dirt to simplify inspecting the pan for leaks.



Figure A-23. Evaporation Pan with Stilling Well and Totalizing Anemometer.

3.3.2 Maintenance. Instruct the Observer to routinely inspect the evaporation pan for leaks. A leaking evaporation pan will invalidate the observations. Instruct the Observer for such a possibility. The Observer needs to enter the date the leak was discovered and the date the pan was replaced or returned to operational service, into the Remarks column of the observations report.

Upon semi-annual site visitation, inspect the evaporation pan to note how clean the water and surfaces appear. There should be no objects or substances in the water that would alter the evaporation rate, such as oil films, algae, leaves, debris, or sediment.

The interior or exterior of the pan should never be painted. This would alter the evaporation characteristics. In order to compare measurements between sites, ensure all pans have identical characteristics.

Under no circumstances should the pan be lifted and emptied with a significant amount of water in it. This action can split or bend the pan. Most of the water should be siphoned or dipped out first. A length of plastic water hose can be used to siphon out the water.

During months when freezing conditions are likely, empty, clean, and store the pan, preferably indoors. If the pan is left in the fenced enclosure, it should be turned upside down and secured to the support with a strong rope.

3.3.3 Control of Algae. As NWSREP you supply the observer with eco-friendly Algaecide or Copper Sulfate to suppress growth of algae.

If algae becomes a problem, you will need to thoroughly empty and clean the Evaporation Pan. Prior to emptying the pan, you can instruct the observer to remove excess Copper Sulfate by placing several “iron penny nails” in the pan overnight. The nails should not be coated or plated. The nails should not come into contact with the sides or the bottom of the Evaporation Pan. You can instruct the observer to place the nails on a plastic sheet, or suspend the nails from a string. The nails should be used only once.

The color of the water will change from blue, to orange, to clear with a muddy brown precipitate. Siphon the water from the Evaporation Pan into a multi-gallon container with a section of garden hose. Empty the multi-gallon container into a sink. Repeat until all water is drained. Do not pour on the ground. Place precipitate in the trash.

3.3.4 Water Storage Tank. If clean water is not available at the site, a storage tank should be installed. The tank should be placed where it will not shade or reduce wind flow over the pan. Thoroughly clean the tank at the beginning of the evaporation measuring season. Ensure the water is completely free of oil.

When the season ends, empty the tank and secure it to prevent freeze and wind damage.

### 3.4. Measuring Instruments.

3.4.1 Fixed Point Gage. The fixed point gage consists of a pointed rod mounted in a tube called the stilling well. It is placed inside the evaporation pan, one foot from the north edge. The stilling well makes readings more precise by eliminating wind-caused surges and ripples in the water level.

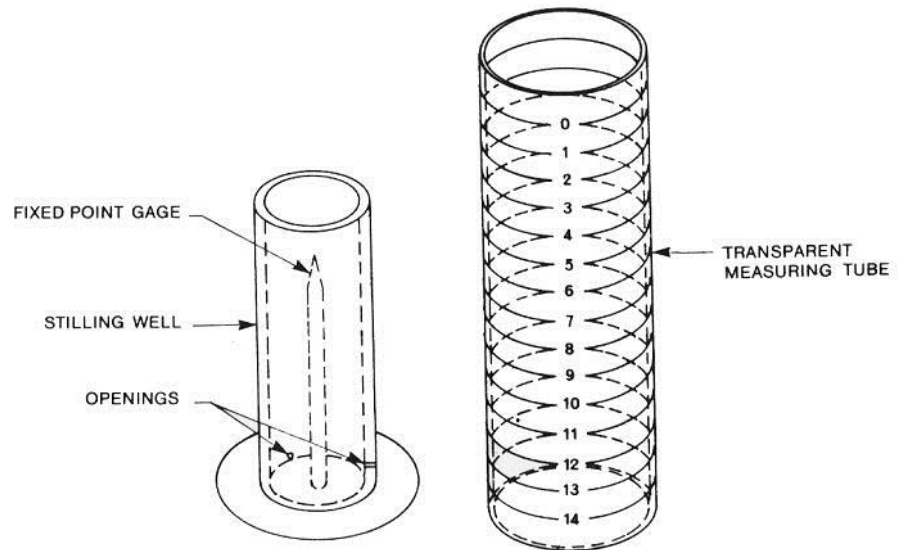

Figure A-24. Stilling Well, Fixed Point Gauge and Measuring Tube

The stilling well is 2.5 to 3.5 inches in diameter and 10 inches tall, and is attached to a base. All parts are made of non-corrosive metal (Figure B-36). The base is heavy enough to resist being moved by the wind. The stilling well has two small openings, 1/8 inch in diameter, located opposite each other near the base. Openings permit the flow of water in and out of the stilling well.

The pointed rod is 1/4 inch in diameter. It is attached to the center of the base inside the well. The point is 7.5 inches above the bottom of the evaporation pan when in position.

Replace evaporated water. This is accomplished by using the transparent measuring tube, shown beside the stilling well in Figure A-24. The tube is 15 inches deep with an inside diameter of 4-3/4 inches, which is one-hundredth of the surface area of the evaporation pan. The tube is graduated at one-inch intervals, with the zero mark at the top. One inch of water in the measuring tube is equivalent to 0.01 inch in the evaporation pan.

3.4.2 Hook Gage. The Hook Gage is no longer supported by NWS logistics as a replaceable part. The Hook Gage allows the water level to drop over respective successive readings; this changes the exposure of the water surface to its surrounding environment. In contrast, the Fixed Point Gage resets the water level to a constant exposure at each reading. In order to obtain more constant measurements and simplify operations, the NWS no longer supports use of the Hook Gage. This section is included for historical and reference purposes.



Figure A-25. Hook Gage

3.5 Totalizing Anemometers. A standard 3-cup, 5-digit counter anemometer (Figure A-26) is mounted on a wooden pan support.

3.5.1 Installation. The anemometer is mounted on a specially designed display stand pintle on the northwest projecting corner of the pan support. The center of the cups should be 6 to 8 inches above the rim of the pan. In this position, the shadow of the cup falls on the pan only during the late afternoon. The anemometer retaining screw (the knurled head set screw located in the adaptor at the bottom end of the anemometer) is used to attach the anemometer to its support base. This screw should be turned only hand-tight.

3.5.2 Maintenance. Service and clean the anemometer on your routine inspection trips, normally twice a year. Bearings of an anemometer lacking oil will squeak and wear badly within a few hours. Inform the observer he/she is to report to you as soon as possible any time the bearings make a squeaking sound. A squeaking anemometer should be removed and replaced with a new one and sent to the National Reconditioning Center for service.

3.5.3 Wind Movement Readings. The anemometer counter is read daily at the scheduled time of observation to the nearest whole mile. For example, if the counter shows a total wind movement of 9291.3 miles, 9291 is recorded.





Figure A-26. Totalizing Anemometer (Legacy)

3.5.4 Data From 5-Digit-Counter Anemometers. The five digits appearing in the window of the meter indicate the total wind movement in tenths of a mile for any total from zero to 10,000 miles. The right hand digit indicates tenths of a mile.

Generally, the cooperative observer will not have to compute the number of miles of wind movement since the previous reading. When the observer is asked to compute the miles of wind travel, the procedure is to subtract the previous day's reading from the number currently on the counter. When 10,000 miles have accumulated, the reading starts over at zero. Thus, when the current day's reading is less than the preceding reading, compute the 24-hour wind movement by adding 10,000 to the current reading. Subtract the preceding reading from this total. For example, if today's reading is 0109 and the previous reading 9986, subtract 9986 from 10109. The movement will be 123 miles.

3.5.5 Data from 6-Digit-Counter Anemometers.

The Totalizing Anemometer is equipped with a built-in counter to provide a simple, yet precise, method of determining miles of wind with total air passage. An internal gear train converts cup rotation to counter input. Miles of wind accumulate the same as a 5-digit anemometer. The 6-digit counter is **not** manually re-settable. The wind can typically accumulate for a year or longer (up to 99,999.9) before it automatically rolls over to zero. See Figure A-27.

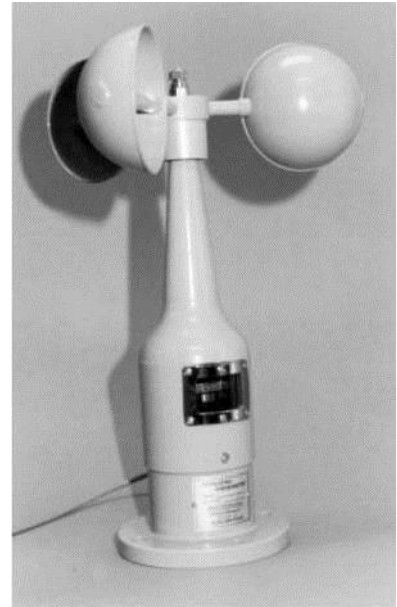

Figure A-27. Totalizing Anemometer with 6-Digits

Upon failure of the older totalizing anemometer models seen in Figure A-26 and Figure A-27, offices may request the black three-cup model, as illustrated in Figure A-28. However, the National Logistics Support Center (NLSC) has a very limited supply.



Figure A-28. Totalizing Anemometer (ASN Part F106-1)

3.6 Water Thermometers. Under standard conditions, the rate of evaporation increases rapidly with increasing water temperatures when the pan is influenced by air motion or sustained breeze.

Maximum and minimum temperatures are determined from sensing elements placed beneath the surface of the water in the evaporation pan. Evaporation occurs at the immediate surface of the water. Since warmer water is lighter than colder (if above 39°F), it will rise to the top and tend to stratify there during the day, especially with the sun shining; therefore, the thermometer should measure the water temperature preferably near the bottom of the pan.

Water temperatures can be measured with the maximum and minimum (Six's) thermometer, as shown in Figure A-29.

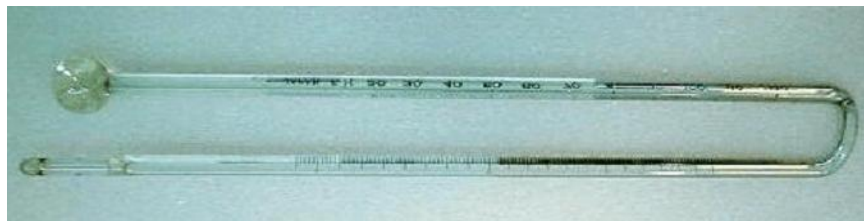

Figure A-29. Six's Thermometer

3.6.1 Submerged-Mount Thermometer. The submerged-mount thermometer is mounted horizontally on a plastic holder which rests on the bottom of the pan (Figure A-30). A non-magnetic metal handle is fastened to the bulb end of the holder and hooks over the edge of the pan. The holder should be located on the inside bottom (south side) of the pan, to be shaded as much as possible from direct sun rays. Submerge the thermometer gently to prevent the small indices inside the tube from jarring away from the mercury column.



Figure A-30. Submerged Mount Thermometer

3.6.2 Recording Thermometers. Any recording thermometer with an immersible sensing element may be used. The line connecting the thermometer to the recorder should be long enough to permit installation of the recorder where it will not cast a shadow on the pan, and more than four feet from any instrument. It should be in a low housing along a fence in the northern half of the enclosure.

3.6.3 Long Stem Digital Max/Min Thermometers. A 20-inch battery powered digital recording maximum/minimum thermometer called 'TW24' will serve as the instrument to measure maximum and minimum water temperatures at stations that no longer have a functional Six's thermometer. Network wide replacement of the Six's is not authorized. The Six's will be

replaced on a site by site basis, when they no longer function. The TW24 requires a holder to be constructed and mounted to the rim of the evaporation pan. Several designs can be constructed with simple off the shelf parts from a home improvement store.

For procedures on how to call up the maximum, minimum, and current temperature readings, see Appendix B, Section 3.2.2.4, of this manual.



Figure A-31. PVC Holder for Long Stem Digital Thermometer



Figure A-32. Position the Long Stem Probe into Shaded Side of Pan

#### 3.6.4 Maintenance – Long Stem Digital Max/Min Thermometers.

Keep the long stem digital max/min thermometers display head free of condensation. The top of the holder will have a cap so the bottom of the holder should be open to the outside air.

The TW24 uses a button cell battery with the package type A76 or LR44. These alkaline batteries are not stocked by NLSC, yet they are available commercially and are inexpensive. Always replace the battery at the start of the season and any time you deploy a unit that was received directly from the National Logistics Support Center.



Figure A-33. Battery Cell for Long Stem Thermometer

## 4. SOIL TEMPERATURE INSTRUMENTATION

4.1 Introduction. Soil temperatures are essential to the agricultural industry. All species of plants have a specific range of temperatures in which they will grow. Most seeds require a certain amount of warmth in order to germinate. Some vegetation will suffer if the soil temperature is too warm.

Many stations measuring soil temperature transmit their readings over nationwide communications circuits, especially during the beginning and middle portions of the growing season. Nationwide weekly average soil temperatures are published during the growing season in the Weekly Weather and Crop Bulletin, and daily readings for one or more levels are published in “Climatological Data” by the National Centers for Environmental Information (NCEI).

Soil temperature stations may have the following additional instrumentation: precipitation gauge, air temperature sensor, evaporation pan, and anemometer.

4.2. Site Requirements and Maintenance. The plot should be 10 by 10 feet or larger, with the thermometers centrally located. Where both sod and bare plots are maintained, the bare plot should also be at least 10 by 10 feet. If the location is not typical of the surroundings, the plot should be larger, at least 30 by 30 feet.

4.2.1 Instrument Exposure. Soil thermometers should have an exposure to represent the principal agricultural soils and conditions of the area. The site should not be subject to irrigation, overflow, or unusual ground-water conditions. The site should be open to full sunshine, with the exception of certain designated sites or where partial shade is considered typical of the area. The observing plot should be fenced or have other protection from humans and animals.

4.2.2 Sod-Covered Plots. Sod-covered plots should be under bluegrass, alta fescue, perennial rye, or other grasses used for lawns or pastures in the area. The area should be trimmed and maintained at a uniform 2 or 3 inch height. No irrigation should be applied, except to start cover before beginning observations. If during extreme drought, it is necessary to irrigate, the soil temperature should be noted as not being typical and should be excluded from published data.

4.2.3 Natural Cover. At some locations, normal climate and soil do not permit maintenance of a sod cover. The observer should maintain the cover like the natural cover common to the area.

4.2.4 Bare Soil. Bare soil plots should be kept free of weeds and other vegetation at all times. This can be done by scraping with a hoe or by chemical treatment. Shallow raking to avoid heavy crusting after precipitation is recommended. Avoid deep cultivation.

Local jurisdictions should be contacted in regard to herbicides that will be best suitable for particular type of soil and vegetation. License and/or permission to apply herbicides should also be verified with the property owner. Refer to environmental polices stated in [NWSM 50-5116, \*Environmental Management\*](#).

4.2.5 Snow Cover. Snow cover should remain natural and undisturbed. The observation site should be located to avoid or limit artificial drifting or wind scouring. The site should allow snow to fall free of obstructions and to accumulate naturally on the ground.

4.3 Depth of Soil Temperature Measurements. The following depths (in inches) for observing soil temperature have been recommended by the Commission for Climatology (CCI) and the Commission for Agricultural Meteorology (CAgM) of the World Meteorological Organization (WMO): 2, 4, 8, 20, 40, 60, and 120 inches.

The two-inch depth was suggested only by the CAgM, for agricultural purposes. This depth is extremely sensitive to micro scale differences in soil type and color, moisture, and vegetative cover. It has been found difficult to maintain an accurate two-inch depth, especially with a bare soil cover. The 60- and 120-inch depths were recommended only by the CCI, for climatological purposes.

Many soil temperature measuring stations record temperatures only at the 4-inch depth.

Where a choice of depths is required due to sensor limitations, the NWS recommends the following order of priority: 4-inches; 8-inches; 20-inches; 40-inches; 2-inches; 60-inches; and 120- inches.

4.4 Types of Thermometers and Readings. Dial-type or digital thermometers may be used. Maximum/minimum and current temperatures are measured at the shallower depths. At greater depths where temperature changes are slower (generally, below the 8-inch level), the current temperature is usually recorded. At most observing sites, maximum and minimum air temperatures are read and recorded at the same time and location as the soil temperatures. See Appendix B, Chapter 5, for a description of the Palmer soil thermometer.

4.5 Installation of Thermometers. Sensing elements should be located in and under undisturbed soil. The sensors should be in close contact with the ambient soil, with no insulating air spaces or pockets, and without artificial channels for the entry of water. They should be in or very near the center of the observation plot. Readouts should be mounted high enough above ground to make it easy and convenient to read and reset the thermometers.

Dig a small trench just to the north of the spot where the sensors will be imbedded in the earth. This should be as small as possible without hindering the necessary work. Remove the sod carefully and set it aside on boards or a tarpaulin for replacement later. The soil should be removed in layers, as it can be replaced as close to its original condition as possible.

The trench should be slightly deeper than the assigned depth for the lowest sensor. This allows enough working space and permits a slight looping of the flexible cables to be installed. A hole should be made for the sensing elements with a rod 18 inches long and 5/16 inch in diameter for installing the 13-inch long mercury-in-steel sensors used with the Palmer soil thermometer. See Figure A-36, which shows the Palmer Soil Thermometer.

The rod should be pressed into the face of the south end of the pit at the proper depth and be driven into the soil nearly its full length. It should remain parallel to the surface above it so that it is the same depth throughout its full length. If smaller sensors (such as thermistors or thermocouples) are used, a rod with a diameter equal to or only slightly larger than the sensor should be used. See Figure A-34, which shows the instrument trench (un-shaded area) as it would appear before replacing the soil.

Press the sensing element into the hole with the least force possible. If too much resistance is met, withdraw the element and clear the hole with the rod.

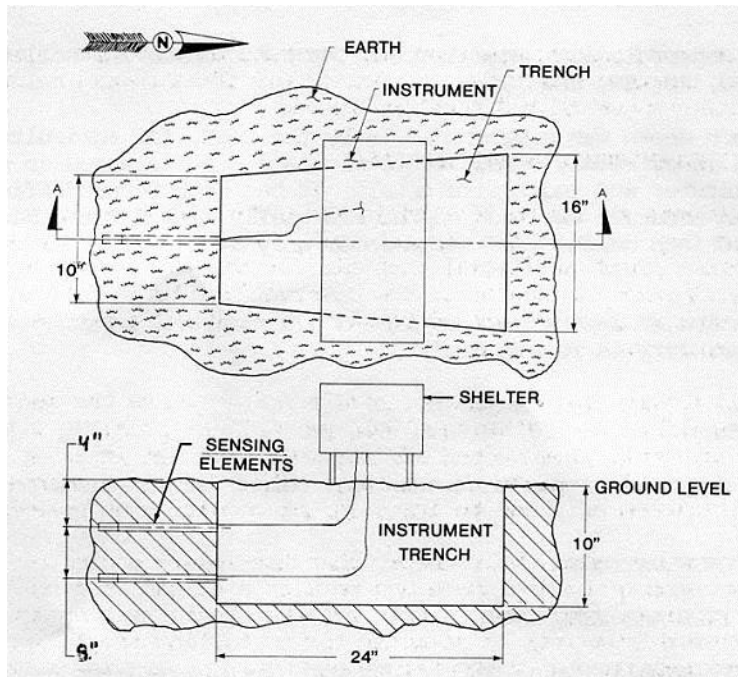

Figure A-34. Installation of Soil Thermometers

The soil should be replaced as nearly as possible in its original condition. This will usually require firm packing as each layer is replaced. Soak the soil as it is returned to the trench, then replace the sod. Excess moisture will assist in renewing sod growth.

#### 4.6 Shelter for the Readings Display.

4.6.1 Types of Head Shelters. Protect soil temperature thermometer heads or recorders from the weather by an enclosable shelter, in which the access door opens from the side or top. The size of the shelter depends on the number of thermometers installed. Soil temperatures measured with an electronic thermometer will have the display mounted in or near a shelter housing of the air temperature sensor (i.e., Cotton Region Shelter).

4.6.2 Location of Shelter. The shelter should be located about one foot north of the south edge of the trench. Set the supports for the shelter in the trench before replacing the soil. The 5-foot cable will permit the shelter to be about three feet above ground. This will allow for a slight loop of the cable in the trench floor for sensors as deep as eight inches.

The shelter may be located outside and to the north of the trench, where no shadows will affect the soil above the sensors, if you have sufficiently long sensor cables to connect the thermometers to the recorders - as with the NIMBUS/MMTS. Trench the temperature cable(s) into the earth a few inches. Do not run them across the ground surface.



Figure A-35. Palmer Soil Thermometer Display in Shelter

4.7 On-Site Accuracy Checks. Verify the accuracy of the soil thermometers twice per year. Incorrect data resulting from long-term calibration drifts can be eliminated with careful accuracy checks once per year at sites that observe only soil temperature. Soil temperature thermometers should be accurate to  $\pm 2.0^\circ\text{F}$ , at three reference temperatures of  $20^\circ\text{F}$ ,  $50^\circ\text{F}$ , and  $100^\circ\text{F}$ .

4.7.1 Palmer Thermometer. The following procedure may be used in the field to accomplish a comparison check to determine if a full accuracy check is warranted.

Obtain a steel rod at least  $5/16$  inch in diameter and at least 30 inches in length in order to bore a hole in the ground to serve as access to the Palmer Thermometers. Carefully review the area to determine where the instrument trench extends and to locate approximately where the sensing element extends. Do not bore a hole closer than 12 inches from the buried probe. The bore should be at least within ten feet of the probe to test under the same type of soil. Bore one hole for each of the various depths being tested. When boring the hole, use locking jaw pliers to hold the steel rod while pounding into the ground.

**Caution: Never hold the steel rod with your hand when pounding the rod into the ground.**

Great care should be used while creating the bore holes. Always use personal protective equipment. Extra care should be exercised when removing the steel rod to diminish the risk of injury. The bore hole should reach only so deep as to match the installed depth of the Palmer Thermometer probe (i.e., 2 inches, 4 inches, 8 inches, or 20 inches). Then the tip of the long-stem digital maximum/minimum thermometer will be in contact with the same depth of soil.

Carefully, slip the long-stem digital thermometer (i.e., TW24) into the bore hole, until the tip is resting on the bottom, and allow five minutes for the thermometer readings to stabilize. Do not push the TW24 into the earth by pushing on the display head.



Compare the test thermometer reading with the Palmer Thermometer reading. If the TW24 shows readings greater than  $\pm 4^\circ\text{F}$  compared to the Palmer display, then you will need to document the discrepancy in the Remarks section of the SIS Station Profile. Then, make plans to return the Palmer thermometer to the National Reconditioning Center for evaluation.

4.7.2 Palmer Model 35B. Check the accuracy of the Palmer model 35B twice per year. Follow the same instructions as described in Section 4.7.1, in the preceding section.

Make the following two allowances for discrepancies between the Palmer model 35B and the check thermometer.

- a. The tolerance of the Palmer (about  $\pm 2^\circ\text{F}$ ) and the check thermometer (generally 1% of the scale) may be additive.
- b. A seemingly slight difference in exposure between the two may contribute to a variation in readings. A spread of up to  $4^\circ\text{F}$  between the two readings should be considered satisfactory.

Note: Never apply any allowable difference as a correction to future observations.

4.7.3 Calibration of the Palmer Thermometers. If one of the Palmer thermometers has a known inaccuracy that can be corrected by a re-set of the calibration, then calibrate the thermometer as follows:

- a. Carefully slide the sensor probe out of its berthed position, by way of the instrument trench (Figure A-34).
- b. Place both the probe and the reference thermometer in the shelter housing of the dial indicator and close the door.
- c. After a minimum of 10 minutes, open the door and record both readings.
- d. Immerse both the reference thermometer and the entire probe of the Palmer thermometer in a slushy ice bath.
- e. After a minimum of 10 minutes, record the temperatures. Leave the sensors in the ice bath, in case step (g) is required.
- f. If the difference in the readings of the two thermometers is approximately the same in steps (c) and (e), an offset is indicated. See step (g) below. If the differences are not approximately the same, the Palmer is considered inoperative and replaced.
- g. If an offset is indicated, turn the “reset” screw on the back of the dial head until the thermometer reads  $32^\circ\text{F}$  while the probe is still in the ice bath. On some older instruments, you need to remove an access-screw in back of the dial head, first.

The adjustment on these models is limited to about two degrees. If a greater adjustment is needed, remove the bezel ring and glass cover. Place a screwdriver in the center screw of the black pointer hand and loosen it. Rotate the pointer hand gently to the desired setting. Re-tighten the center screw.

4.8 Maintenance of the Palmer Thermometers. The most common maintenance needs of the Palmer soil thermometer are as follows: loose or frozen pointers, moisture in the head, broken cover, and calibration errors.

4.8.1 Loose Pointers. This usually results from improper resetting procedures. This is corrected by removing the bezel ring and glass cover (the red and green pointers are mounted in the glass cover). Remove the Allen set-screw embedded in the green knob. The tightness of this knob controls the tension on both pointers. Hold the bottom of the connecting shaft (inside the glass cover) and carefully reset the green knob to the desired tension. Clockwise rotation increases the tension. Replace the Allen set-screw in the green knob and reassemble. Replacing the tension washer under the green knob may be necessary.

4.8.2 Frozen Pointers. Frozen pointers can often be corrected by cleaning and lubricating. Use a good silicone lubricant. It may be necessary to remove the bezel ring and glass cover to perform adequate cleaning and lubrication.

4.8.3 Moisture in the Head. This indicates the need for a new gasket. Remove the bezel ring and glass cover. Replace the sealing gasket on a day with as low humidity as possible.

4.8.4 Broken Cover. A file or hacksaw may be required to remove the bezel ring. Make a cut across the outside edge of the ring. Then use a screwdriver to press downward and outward to snap it off. A new cover and ring should be replaced with a connecting screw to fasten it in place.



Figure A-36. Palmer Soil Thermometer

## 5. RIVER STAGE INSTRUMENTATION

5.1 Introduction. The NWSREP is responsible for the non-automated river stage gauges owned by the NWS. These include three types of equipment, the Wire Weight Gauge, the Staff Gauge, and the Profile Gauge. Check the Station Information System (SIS) metadata (i.e., Station Profile) to determine ownership.

Note: Automated gauges owned by another agency (i.e., USGS) should be removed from the SIS data base because they are not part of the COOP program. The NWSREP is not responsible for maintenance of automated river gauges.

The term “stage” is the height of the water surface above an established datum or reference elevation. The term “gauge height” is used for readings from a gauge, but stage and gauge height are often used interchangeably. The datum may be a recognized elevation such as mean sea level or an arbitrary datum chosen for convenience.

In either case, the gauge is adjusted for positive gauge heights. This is accomplished by setting the lowest possible gauge height (the case of no stream flow) to a value of zero. The elevation of the zero gauge height is referenced to the datum by running levels to a reference mark which has a known elevation relative to the datum. It is important that an elevation reference mark for the datum be located (or established) that is permanent even if the gauge is destroyed.

River stages are affected by many factors. Precipitation and temperature are the most commonly known causes of rises and falls in river stages, but river stages may also be affected by the release of water from upstream reservoirs.

Precipitation readings at river cooperative stations are taken with the four-or eight-inch non-recording gauges (Section 1, Appendix A). River stages are read using a staff, wire weight, or profile gauge, as described below.

5.2 Safety Precautions. The NWSREP reads the NWSM 50-1115, *NOAA Occupational Safety and Health Manual* and ensures the Observer is aware and obtains any special equipment that includes and is not limited to: reflective vests, personal protective gear, safety harnesses, boots, and gloves.

Read and apply the important precautions identified in NWSM 50-1115, Procedure 1, ‘*Fall Protection*.’ Ensure you are aware of the safety aspects or lack of safety protections at the site. Are there guard rails or walkways that are protected from traffic, and the risk of falls?

Read and apply the important precautions identified in NWSM 50-1115, Procedure 2, ‘*Working Alone*.’ The NWSREP inspects the river observation site at least once per year and documents any changes in site conditions and safety to the SIS Station Profile.

If there are potentially unsafe conditions determine if it is possible to reduce risk to the observer, and communicate to the observer for what special precautions need to be taken. If they are not possible, then consider removing the equipment and closing the site.

If the site is subject to hazardous weather or hazardous river conditions, then propose to the observer a set of guidelines or criteria for which an observation will not be taken. Inform the observer some sites and conditions may warrant an assistant to help take the observation.

**Bridge Cautions:** Safety considerations require the railing on the bridge be no lower than 42 inches for any wire weight gauge installation. If the railing is lower than 42 inches, then remove the equipment and relocate to another site if possible.

If the roadway authority has restriped or widened the lanes or taken away part of the roadway shoulder and the risk from traffic is worse than before, then notify your NWSREP.

**General Cautions:** Remind your observers to be vigilant of their environment and the risks presented by vehicular traffic. Instruct them to avoid parking or standing in any location that would cause a risk to themselves or a diversion to vehicular traffic.

If roadway conditions have deteriorated, or ground conditions near the gauge have deteriorated, or equipment cannot be maintained at the site consider closing the site.

**Note: Warn your observers to never risk injury to collect data.**

5.3 River Gauge Location. The purpose of the river gauge is to obtain a stage measurement at the river crest, recording the approximate time of occurrence. It is also very helpful to take observations, both as the river begins a significant rise and as it recedes from a crest. These reports, even when not transmitted, will be valuable input to computer models that relate precipitation to river stage, and to determine the relationships of river stages at different points on the river.

5.3.1 Site Selection Criteria. Consider the following factors when selecting a site for the river gauge:

- a. The gauge should be located so river stages will best reflect flooding in the area of maximum damage potential.
- b. There should be access to the gauge during high water, if at all possible.
- c. The gauge should not be located in the backwater of a reservoir or of a main stem river, if possible.
- d. The river banks at the gauge site should be stable.
- e. Safety considerations require if a wire weight gauge is located on a bridge, the railing will be no lower than 42 inches. There should also be enough room for the observers to perform their job without having to worry about traffic. If either of these situations exists, the gauge should be moved or the safety of the location improved. Follow instructions in NWSM 50-1115.

5.3.2 Relocating River Gauges. A river gauge should be moved only after all other options have been exhausted. A different river gauge location is likely to change such forecast components as the relationship of the gauge reading to the discharge rate, flood wave travel time and attenuation, and flood stage. Moving the gauge may add or exclude a significant tributary from the drainage area. All users of the stage data will be informed of the change.

A new or moved river gauge location will mean establishing a new gauge datum if an arbitrary datum is used. If mean sea level is the datum, a bench mark or a new reference mark with known mean sea level will have to be located. It will then be necessary to run levels from the known elevation to the new gauge site.

A wire weight gauge will require a new Check-Bar elevation determination, while a staff gauge will require the individual gauge sections be set to given elevations above the datum.

5.4 Staff River Gauge. The staff river gauge (Figure A-37) is a fixed scale that can be in the form of porcelain-enameled iron sections, a wooden plank, or may be printed on available structures such as a bridge, pier, or wall. The gauge may be mounted vertically or inclined with graduations for vertical depth. The inclined gauge is used where ice or debris will not permit a permanent vertical staff to be installed.

It usually consists of a heavy timber installed on the incline of the bank. The scale of the staff gage is set so a reading can be taken at zero flow in the low-water channel. Readings are made to the nearest tenth of a foot. The staff gauge will usually have a gauge datum that will be the elevation of its zero reading referenced to mean sea level.



Figure A-37. Staff Gauge

The gauge sections should be set so the readings are heights above the datum.

If vertical movement of the supporting structure occurs, such as settling, erroneous observations from the staff gauge will result unless levels are run from a reference of known elevation and the staff scale is reset.

If the gauge has a scale marked with graduations above and below zero, then record the below zero readings on the report with a minus sign (i.e., -0.3). If possible, the gauge should be set so as to avoid negative values.

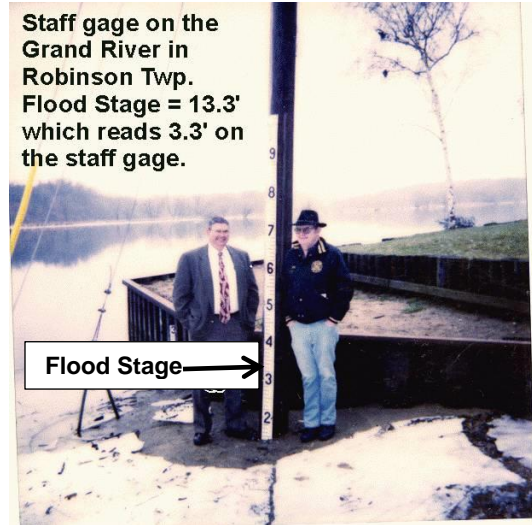

Figure A-38. Reading the Staff Gauge

## 5.5 Wire Weight Gauge.

5.5.1 Description. The wire weight gauge (Figures A-39) is permanently mounted inside a lockable cast metal box attached to a bridge or similar structure. The gauge consists of a drum wound with a single layer of stainless steel cable, a bronze or brass weight attached to the end of the cable, a graduated disc, and a counter. The drums disk is graduated in tenths and hundredths of a foot and is connected to the counter which advances by one with each full revolution of the drum. The cable is made of 0.015 inch stainless steel wire, geometrically wound, and is guided to smoothly fill the drum by means of a threaded sheave. The wire weight reel assembly is equipped with a ratchet used to lock the drum and cable in any position by means of a pawl.

In order to check the Check-Bar reading of the wire weight gauge, slide the Check-Bar at the bottom fully forward toward the drum. When in this position, the cable weight when released can rest on the Check-Bar. When the weight is resting on the bar with no slack in the cable, the combined reading from the counter and the number of graduations on the graduated disk equals the current Check-Bar reading.

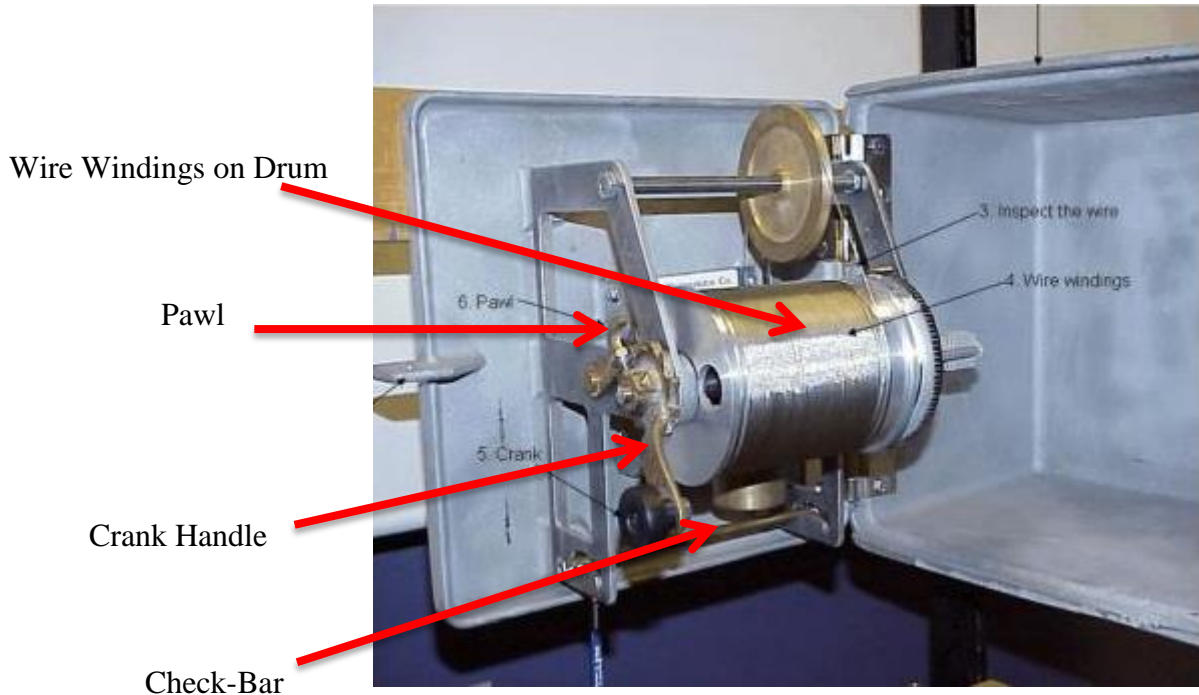

Figure A-39. View of Wire Weight Gauge Inside Metal Box

The cable drum is fastened to the handle and shaft assembly by a friction clamp which, when loosened, allows the handle and shaft attached to the counter to turn independently of the cable drum. This allows the cable, weight and drum to be held in place on the Check-Bar while the handle is turned to obtain the desired Check-Bar reading on the counter and graduated disk. When the handle shaft assembly is released from the drum cable assembly, hold the cable drum in place by hand, to keep the weight from free falling.

**5.5.2 Installation.** It is important to note that the NWSREP is only responsible for the installation and maintenance of NWS owned wire weight river gauges. Gauges owned by another agency are the responsibility of that agency. The wire weight river gauge is traditionally mounted on the upstream side of a bridge above the main channel of the river or stream. The wire weight can be attached to the bridge using several methods. In some cases, the gauge is mounted to the bridge with bolts or it can be mounted using straps which secure the gage to the railing. The method of mounting is dictated by the owner of the bridge.

A safety railing is required to be installed if the existing bridge railing is less than 39 inches high.

Many newer bridges have a concrete barrier on each side of the bridge which necessitates the use of a hanger strap that can be fashioned for the particular bridge. \* Consult with the owner of the bridge targeted for installation of a wire weight gauge to solicit approved methods of mounting the gauge. Never mount a wire weight gauge on a bridge without help. It is a **two person** job.

\* Get approval in writing from the bridge owner before installing gauge.

When the gauge is mounted on the bridge, levels have to be run for the gauge. Consult with the owner for benchmark/reference elevations. Often the owner will agree to run a level for the wire weight's Check-Bar. This will save considerable work for the NWSREP. The ultimate objective of running a level on the new gauge is to develop a Check-Bar setting.

**5.5.3 Re-Installing a Wire Weight Gauge at an Established Site.** When installing a wire weight gauge at an established site, the gauge zero is established. If acceptable, the established gauge zero is simply subtracted from the surveyed elevation of the newly installed wire weight's Check-Bar. This is the distance in feet, tenths and hundredths of a foot the Check-Bar is above the gauge zero. The distance becomes the CHECK-BAR READING for the newly installed gauge. The new Check-Bar reading should be documented in the Station Profile in the Station Information System (SIS). The new Check-Bar setting should be immediately made available to the Service Hydrologist (SH) or focal point, the River Forecast Center (RFC) and the Cooperative Observer.

When the wire weight's observed Check-Bar reading differs by 0.03 feet or more from the official Check-Bar established for the station, ensure the Check-Bar reading of the gage is brought back within tolerance. Assuming adjustment is necessary:

**Important.** Never adjust the gauge of another agency. Report any errors to the owner of the gauge.

- a. Note the difference upon inspection.
- b. Rest the weight upon the Check-Bar assuring the cable is taught.
- c. While holding the cable and drum, loosen the two large screws which secure the cable drum to the graduated disk.
- d. Turn the crank handle until the counter and graduated disk indicate the desired Check-Bar reading.
- e. Tighten the two large screws. Do not let go of the cable drum until both screws are tightened.
- f. Recheck starting at "b." Re-adjust as necessary.
- g. Lock the drum with the ratchet pawl.
- h. Move the Check-Bar to the rear to allow the weight to be lowered.
- i. Lower weight to water level and rewind.
- j. Verify correct Check-Bar reading of gauge.



- k. When the correct Check-Bar reading is obtained, the gage crank handle may require adjustment to permit closing of the gauge cover. This is accomplished by loosening the two small bolts which secure the handle to the shaft and repositioning the handle to allow closure of the cover. Re-tighten both bolts when repositioned.
- l. Lock gauge.
- m. Notify the Senior Hydrologist of wire weight Check-Bar readings before and after adjustment.

5.5.4 Replacement of a Lost Weight. When a weight is lost from a wire weight river gauge, determine the amount of cable remaining on the drum before deciding on the correct method of repair. This can be determined by winding the remaining cable on the drum and counting the number of feet of cable left. One complete revolution equates to one foot of cable. Ensure you evaluate the condition of the remaining cable. If frayed or kinked, cable replacement should be considered.

If the remaining cable on the wire weight is in acceptable condition and sufficient cable remains on the drum to allow the weight to extend several feet below gauge zero, a new brass weight can be installed on the existing cable. (See Figure A-40).

The cable is required to be replaced if the remaining cable on the wire weight is unacceptable or if it is too short to extend several feet below gauge zero. When considering installation of a new cable, it is suggested that the drum be filled to near capacity (100 feet) regardless of the amount required to attain the necessary length. This process of installing a full drum of cable could allow several future weights to be replaced without adding new cable.

Cable replacement begins with the removal of the old cable. It can be easily unwound. **Note how the old cable is secured to the drum.** Attach the new cable in a similar manner. When attached to the drum, move the guide wheel on the threaded shaft to where it is directly above the point on the drum where the new cable is attached. Route the new cable over the brass guide wheel.

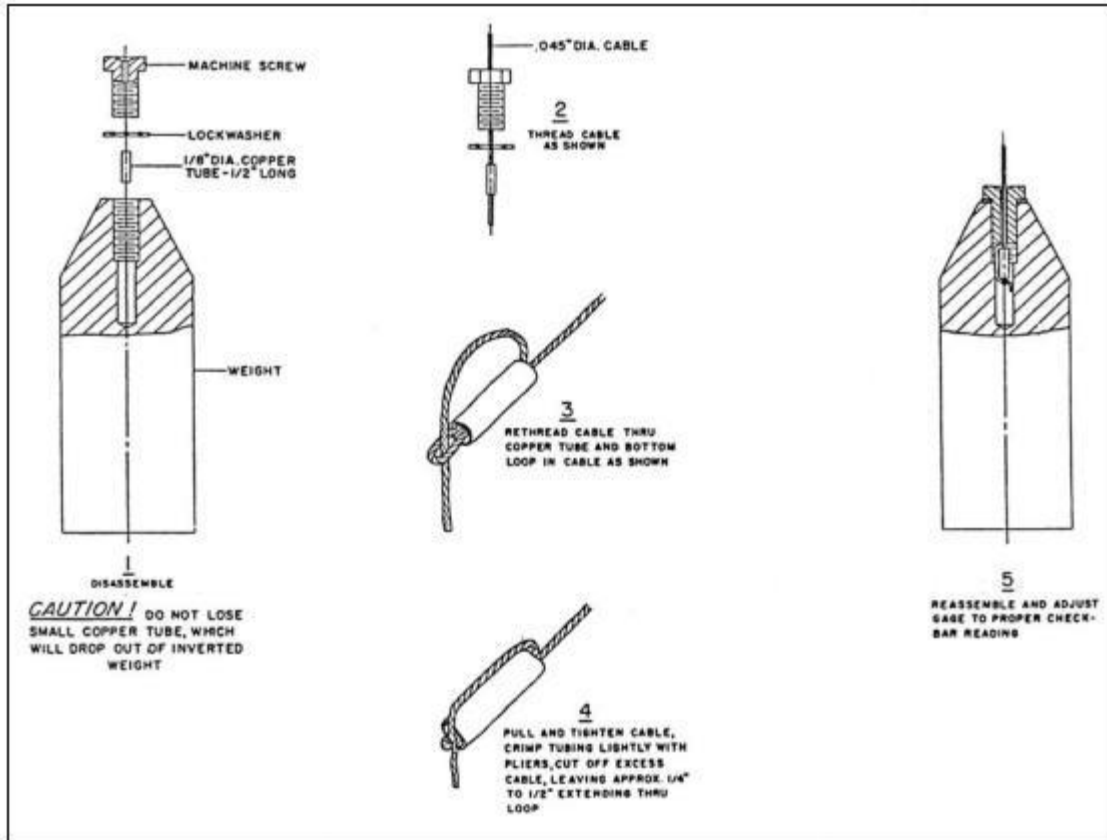

Figure A-40. Install the Brass Weight Securely in Five Steps

While continuing to hold the cable taut as it extends from the drum across the guide wheel, use the gauges crank handle and wind new cable onto the drum assuring that it fills the drum smoothly and evenly.

When sufficient cable is wound onto the drum, the weight can be installed. Tension applied while winding the cable should not be released. If the cable is released, the cable may loosen on the drum and become tangled. Keeping tension on the cable, install the new weight. When installed, route the weight between the guide wheel and gage mounting base to the normal weight position. Keep tension against cable until the weight takes over and provides tension to the cable.

The gauge should be back in operation. Lower the weight to the water level and rewind. The cable should rewind evenly on the drum. Ensure you set the wire weight’s Check-Bar reading, after successful installation of the new cable and weight. Then the gauge is operational.

Routine use/reading of the wire weight river gauge:

- a. While holding the crank handle, release the latch pawl which locks the drum in place.

- b. Assure the Check-Bar is moved completely to the rear (toward you).
- c. Using the crank handle, lower the weight slowly to the surface of the water so the weight is just touching the surface.

**Caution:** If the handle is released when the lock is not engaged the unit will backlash. Severe damage to the equipment or injury is possible.

- d. Read the counter for whole feet. Add hundredths of feet from the graduated wheel on the drum.

Rough water: If the surface is rough, then average the peaks and troughs.

- e. The River Stage reading is the sum of the number on the counter plus the number on the graduated wheel.

5.6 Profile Gauge. On some rivers, especially where man-made structures such as bridges are rare and where vertical or staff gauges can be damaged by ice jams and breakup, profile gauges are used. These consist of a marker, usually a metal strip several inches wide, or a bright painted stripe along an existing concrete or asphalt surface, which extends down toward the water.

Before the gauge is established, surveyor's equipment is used to obtain the profile of the river bank. Measurements are taken from a brass cap benchmark anchored in the bank above the levels of ice movement. From this data, the elevation of the sloped bank is calculated to the tenths of a foot and matched to the stage height of the river. A durable marker (or an indexed painted stripe) can be installed to a stable section of the riverbank.

The difference between the index markings along a Profile Gauge and those on a Staff Gauge is the index markings on the Profile Gauge are spaced farther apart in order to accurately represent the vertical stages in tenths of a foot.



Figure A-41. Profile Gauge

# APPENDIX B - COOP Observer – Observation Instructions

Table of Contents	Page
1. Observer Guidance.....	B-6
1.1 Introduction.....	B-6
1.2 Observer Responsibilities .....	B-6
1.3 Preferred Time for Taking Observations .....	B-6
1.4 Equipment.....	B-6
1.5 Requesting Supplies.....	B-6
1.6 Reporting Equipment or Instrument Problems .....	B-7
1.7 Quality Control of Observational Data.....	B-7
1.8 Data Transmission .....	B-7
1.8.1 WS Form B-82, Official Observer’s Note Pad .....	B-7
1.8.2 WS Form B-91 (Monthly Reporting Form).....	B-7
1.8.3 WS Form B-92 (Record of Evaporation and Climatological Observations).....	B-8
1.8.4 WS Form 1009-ST (Record of Soil Temperature Observations) .....	B-12
2. Precipitation Measurements.....	B-13
2.1 Liquid Precipitation .....	B-13
2.1.1 Four-Inch Non-Recording Gauge .....	B-13
2.1.2 Eight-Inch Non-Recording Gauge .....	B-14
2.2 Freezing Precipitation .....	B-15
2.3 Frozen Precipitation .....	B-15
2.3.1 Snowfall (New Snow).....	B-15
2.3.1.1 Snow Measurement Stick .....	B-16
2.3.2 Snow Depth.....	B-17
2.3.2.1 Snow Depth Stakes .....	B-18
2.3.3 Snowfall Water Content.....	B-18
2.3.4 Snow Depth Water Content .....	B-18
2.4 Reporting Precipitation Observations .....	B-19
2.4.1 Rainfall Reporting.....	B-19
2.4.2 Snowfall Reporting .....	B-19
2.4.3 Snow Depth Reporting.....	B-19
2.4.4 Snowfall Water Content Reporting.....	B-19
2.4.5 Snow Depth Water Content Reporting .....	B-19
2.5 Recording Gauges .....	B-19
2.5.1 Reporting Gauge Problems and System Outages .....	B-19
2.5.2 FPR-D (Sutron) Precipitation Data Reporting.....	B-20
2.5.3 FPR-E (CES) Precipitation Data Reporting.....	B-20
2.5.4 Fischer-Porter Mechanical Gauge Upkeep and Reporting .....	B-21
2.5.4.1 Bucket Draining .....	B-22
2.5.4.2 Summer Maintenance .....	B-22
2.5.4.3 Winter Maintenance.....	B-23
2.5.4.4 Setting the Punch Tape to Correct Time.....	B-24
2.5.5 Consumable Supplies.....	B-25

3. Air Temperature Measurements .....	B-26
3.1 Reading and Resetting the MMTS and Nimbus Temperature Displays.....	B-26
3.1.1 Operation.....	B-26
3.1.2 Convert Temperature to Whole Degrees .....	B-26
3.1.3 Identifying and Correcting Erroneous Maximum/Minimum Temperatures.....	B-27
3.1.4 Display Shows ‘Help’ .....	B-27
3.1.5 Digits in the Display are ‘Blinking’ .....	B-27
3.2 Liquid in Glass (LIG) Thermometers .....	B-28
3.2.1 Reading and Setting the Minimum Thermometer .....	B-28
3.2.2 Reading and Setting the Maximum Thermometer.....	B-29
3.2.3 Reading the Current Temperature.....	B-29
3.2.4 Check Difference Between Max and Min Thermometers .....	B-31
3.3 Correcting LIG Thermometer Errors .....	B-31
3.3.1 Correcting Maximum Thermometers .....	B-31
3.3.2 Correcting Minimum Thermometers .....	B-32
3.4 Mercury Clean-Up .....	B-34
3.5 Logging of Temperature Readings .....	B-35
3.6 Common Errors to Avoid.....	B-36
3.7 Reporting the Air Temperature Observations.....	B-37
4. Pan Water Evaporation Measurements .....	B-38
4.1 Measuring Evaporation.....	B-38
4.1.1 Fixed Point Gage.....	B-38
4.1.1.1 Evaporation Observation Entry (Ordinary) .....	B-38
4.1.1.2 Evaporation Observation Entry If Rain Occurred .....	B-38
4.1.2 Hook Gage .....	B-39
4.1.2.1 Evaporation Observation Entry (Ordinary) .....	B-40
4.1.2.2 Evaporation Observation Entry if Rain Occurred.....	B-40
4.2 Secondary Observations Reported with the Evaporation Observation.....	B-41
4.2.1 Wind Run from Totalizing Anemometer.....	B-41
4.2.2 Water Temperature .....	B-41
4.2.2.1 Reading and Resetting the Six’s Thermometers.....	B-41
4.2.2.2 Rejoining Separated Mercury Columns.....	B-42
4.2.2.3 Six’s Maintenance.....	B-42
4.2.2.4 Long Stem Digital Max/Min Thermometer - Operation.....	B-42
4.2.2.5 Maintenance of the Long Stem Digital Max/Min Thermometer .....	B-43
4.3 Routine Maintenance .....	B-43
4.4 Algae Removal.....	B-43
4.5 Accuracy Checks .....	B-44
4.6 Reporting Pan Evaporation Observations.....	B-44
5. Soil Temperature Measurements .....	B-46
5.1 Time of Observation .....	B-46
5.2 Maximum and Minimum Soil Temperature .....	B-46
5.3 Palmer Soil Thermometer .....	B-46

5.3.1	Resetting Maximum and Minimum Pointers .....	B-47
5.4	Proper Entry of Maximum and Minimum Temperatures .....	B-47
5.5	Reporting Soil Temperature Observations.....	B-47
6.	River Stage Measurements .....	B-49
6.1	Safety Precautions.....	B-49
6.2	Observation Requirements.....	B-49
6.2.1	Criteria Reporting Stations .....	B-50
6.2.2	Daily Precipitation Reporting .....	B-50
6.2.3	Additional Elements to Report.....	B-50
6.3	Wire Weight Gauge Observation.....	B-51
6.4	Staff Gauge Observation.....	B-53
6.5	Profile Gauge Observation.....	B-54
6.6	Reporting River Levels .....	B-54
7.	Atmospheric Phenomena Observations .....	B-55
7.1	Introduction.....	B-55
7.2	Tornadoes, Waterspouts, and Funnel Clouds .....	B-55
7.2.1	Tornado .....	B-55
7.2.2	Funnel Cloud.....	B-56
7.2.3	Waterspout .....	B-56
7.3	Thunderstorms .....	B-57
7.4	Damaging Winds, Squalls, and Gusts.....	B-57
7.5	Hydrometeors.....	B-58
7.5.1	Forms of Precipitation.....	B-58
7.5.2	Hydrometeors Other Than Precipitation .....	B-61
7.6	Lithometeors .....	B-64
7.6.1	Haze .....	B-65
7.6.2	Smoke .....	B-65
7.6.3	Dust.....	B-65
7.6.4	Blowing Sand.....	B-67
7.7	Electrometeors .....	B-68
7.7.1	Aurora .....	B-68
7.7.2	Thunder .....	B-68
7.7.3	Lightning.....	B-68
7.8	Atmospheric Optics .....	B-69
7.8.1	Halo Phenomenon.....	B-69
7.8.2	Corona.....	B-69
7.8.3	Rainbow .....	B-70
7.8.4	Fog Bow.....	B-70
7.9	Reporting and Recording Hazardous Weather .....	B-71
7.9.1	Real-Time Reporting .....	B-71
7.9.1.1	Reporting Tornadoes, Waterspouts, and Funnel Clouds .....	B-71
7.9.1.2	Reporting Other Phenomena.....	B-72
7.9.2	Recording Hazardous Weather .....	B-72
7.9.2.1	Tornadoes, Waterspouts, and Funnel Clouds .....	B-72

7.9.2.2	Thunderstorms .....	B-72
7.9.2.3	Other Phenomena.....	B-72

<b>Figures</b>	<b>Page</b>	
B-1	WS Form B-82, Observer’s Daily Notepad.....	B-8
B-2	WS Form B-91, Example of Temperature and Precipitation Entries .....	B-9
B-3	WS Form B-92, Record of Evaporation and Climatological Observations.....	B-10
B-4	WS Form 1009-ST, Record of Soil Temperature Observations .....	B-11
B-5	Four-Inch Plastic Rain Gauge.....	B-13
B-6	Removing the Measuring Tube.....	B-13
B-7	Reading the Measuring Tube at Eye Level.....	B-13
B-8	Eight-Inch Gauge .....	B-14
B-9	Removing the Funnel.....	B-14
B-10	Removing the Measuring Tube.....	B-14
B-11	Dipping the Measuring Stick .....	B-14
B-12	Measuring the Precipitation .....	B-14
B-13	Reading the Precipitation Amount.....	B-14
B-14	Snow Measurement Board.....	B-16
B-15	40-Inch and 20-Inch Snow Sticks.....	B-16
B-16	Snow Sticks Measure in Tenths of an Inch.....	B-16
B-17	Snow Measurement Board Upon Old Snow .....	B-17
B-18	Snow Depth Stakes .....	B-18
B-19	FPR-D Recording Rain Gauge.....	B-20
B-20	FPR-D Data Logger .....	B-20
B-21	Insert SD Memory Card to Download Last 60 Days.....	B-20
B-22	FPR-E Recording Rain Gauge.....	B-21
B-23	FPR-E Data Logger.....	B-21
B-24	Insert Flash Drive to Download Last 100 Days.....	B-21
B-25	Recorder Components of Fischer-Porter Mechanical Gauge – Casing Removed.....	B-25
B-26	MMTS Control Buttons .....	B-26
B-27	Nimbus Control Buttons .....	B-26
B-28	Reading Thermometers.....	B-28
B-29	Resetting the Maximum and Minimum Thermometers.....	B-30
B-30	Minimum Thermometer – Vertical Position During Resetting .....	B-31
B-31	Maximum Thermometer in Reading Position.....	B-31
B-32	Maximum Thermometer Before and After Spinning.....	B-32
B-33	Joining the Alcohol Column – Tapping Method .....	B-33
B-34	Joining the Alcohol Column – Centrifugal Method .....	B-34
B-35	Proper Entries for Temperature Observations .....	B-35
B-36	Transparent Measuring Tube and Stilling Well Inside Pan.....	B-38
B-37	Fixed Point Gage - Evaporation Measurements .....	B-39
B-38	Hook Gage .....	B-40
B-39	Six’s Thermometer Before Resetting.....	B-41
B-40	TW24 Long Stem Max/Min Thermometer.....	B-43
B-41	On/Off Button is on Right Side .....	B-43

B-42 Report Evaporation Observations into the WxCoder Superform ..... B-44  
 B-43 WS Form B-92, For Observers Unable to Report Electronically ..... B-45  
 B-44 Palmer Soil Thermometer ..... B-46  
 B-45 Form 1009-ST for Soil Temperature Observations ..... B-48  
 B-46 Observer at Wire Weight Gauge ..... B-49  
 B-47 Side View of Wire Weight Gauge ..... B-51  
 B-48 Reading the Wire Weight Gauge ..... B-52  
 B-49 Top View of the Wire Weight Gauge ..... B-53  
 B-50 Reading the Staff Gauge ..... B-53  
 B-51 Reading the Profile (Slope) Gauge ..... B-54  
 B-52 Tornado ..... B-55  
 B-53 Winds Associated with a Tornado ..... B-56  
 B-54 Funnel Cloud ..... B-56  
 B-55 Waterspouts ..... B-57  
 B-56 Distant Thunderstorm ..... B-57  
 B-57 Microburst ..... B-58  
 B-58 Glaze Ice ..... B-59  
 B-59 Hail ..... B-59  
 B-60 Snow Pellets ..... B-60  
 B-61 Snow Grains ..... B-60  
 B-62 Fog ..... B-61  
 B-63 Mist ..... B-61  
 B-64 Ice Fog ..... B-62  
 B-65 Dew ..... B-62  
 B-66 Frost Formed on Window ..... B-63  
 B-67 Rime Ice ..... B-64  
 B-68 Blowing Snow ..... B-64  
 B-69 Haze ..... B-65  
 B-70 Smoke ..... B-65  
 B-71 Blowing Dust ..... B-66  
 B-72 Dust Storm ..... B-66  
 B-73 Dust Devil ..... B-67  
 B-74 Sandstorm ..... B-67  
 B-75 Northern Lights ..... B-68  
 B-76 Lightning ..... B-68  
 B-77 Halo With Sun Dogs ..... B-69  
 B-78 Corona ..... B-70  
 B-79 Double Rainbow ..... B-70  
 B-80 Fog Bow ..... B-71

**Table** **Page**  
 B-1 Propylene Glycol Schedule for Extreme Cold Sites ..... B-23



## 1. OBSERVER GUIDANCE

1.1 Introduction. The National Weather Service (NWS) Cooperative Observer Program (COOP) serves the NWS climate program with official observations of air temperature, precipitation and in some locations additional observations. Once the measurements of temperature and precipitation are taken, the instruments are reset for the next 24 hour period. Some observers measure daily snowfall, snow depth, pan evaporation, soil temperature, and river height. All observations are logged by the COOP Observer and reported to their managing Weather Forecast Office (WFO). The National Weather Service Representative (NWSREP) who receives the data in the WFO then submits the observations to the national center that compiles and archives data for public access.

1.2 Observer Responsibilities. The NWS climate program requires the daily observation of the current air temperature, the maximum and minimum air temperatures, and the precipitation measured at the COOP Observer's sites. The current temperature is the reading taken the same time every day when the maximum and minimum readings are taken. The maximum and minimum temperatures are the highest and lowest temperatures (in whole degrees Fahrenheit) to have occurred in the 24 hours preceding the reading of the instruments. The precipitation is the amount of rain water or melted frozen precipitation in hundredths of an inch. To reduce errors, these observations are taken at the same hour each day. Prior approval is needed to change the scheduled time of the observation. The time of the observations is always entered into the reporting form. When the regular observation cannot be made within an hour of the scheduled time, the observer enters the new time into the reporting form.

Continuity of records is very important. A family member or some other competent person should be taught to take and record observations in the event of your absence or illness. Consult with your NWSREP if you have any questions on how to record and report observations. See Section 2.6, for policy on logging the temperatures to the NWS reporting system.

1.3 Preferred Time for Taking Observations. Stations reporting both precipitation and temperature should report at a time agreed to with the NWSREP. Unless otherwise directed, precipitation and temperature should be observed at the same time each day. Evaporation and soil temperature stations should observe all elements in the morning.

1.4 Equipment. Instruments and equipment furnished to the station should be maintained in accordance with any instructions issued with the instrument. Instruments and equipment are not to be moved or relocated without the approval of the NWSREP. If immediate action is necessary to prevent damage, the cooperative observer will notify the NWSREP promptly. In a similar way, the cooperative observer should notify the NWSREP when the observer has taken action to maintain the exposure of instruments or equipment when the growth of vegetation, trees, shrubs, or other changes have jeopardized the site exposure.

1.5 Requesting Supplies. Instruments and equipment, report forms, envelopes, and all other supplies are furnished by the NWSREP. The cooperative observer should advise the NWSREP promptly when any forms, supplies, or services are needed. This may be communicated by phone, email, or even WxCoder, in order to notify the NWSREP.

1.6 Reporting Equipment or Instrument Problems. NWS equipment and instrument problems should be reported to the NWSREP, in this way repairs or replacements can be arranged. The NWSREP brings the new or replacement parts to the Observer's site and performs the installation or repair.

1.7 Quality Control of Observational Data. Within the first five days of the month, the observer should quality control and close out the month and submit the data via WxCoder. The NWS uses several paperless systems to collect observer data, such as WxCoder, IV-ROCS, removable memory devices. If paperless systems are not used, the observer should mail the original observation form to the NWSREP. The observer using paper should make one backup copy to serve as the official record if the original is lost. The NWS will furnish postage-paid envelopes for the observers who mail forms.

1.8 Data Transmission. Observers are encouraged to use paperless data transmission modes to submit their observations. Observers are asked to report precipitation observations in accordance with the NWSREP's instruction and in agreement with the COOP Observer memorandum of agreement.

Paperless reports are usually done via a website entry system known as WxCoder, or via phone on the Interactive Voice Recognition System (IV-ROCS).

WxCoder is an online computer web based system used for the input of daily observations. IV-ROCS is a telephone system for those observers who don't have access to a computer. Follow the instructions found in the *WxCoder Users Guide*, to properly enter the values of the observed precipitation into the Daily Observation Page. For IV-ROCS users, the NWSREP will provide instructions.

Observers unable to report electronically, are given printed forms (e.g., WS Form B-91) to report the observations. To each of the printed forms, the observer enters his/her station name, county, state, month, year, and time of observation. Note: For observers who use electronic data submission, this information is automatically generated.

1.8.1 WS Form B-82, Official Observer's Note Pad. This small pocket-size form is intended as a note pad to save the readings observed on the instruments until such time you log the readings into the official reporting system (i.e., WxCoder or IV-Rocs systems). Remarks that may need to be reported for the official observation can be written to WS Form B-82 (See Figure B-1).

For observers unable to report electronically, the readings from the note pad support your completion of the observation entries to the WS Form B-91 (paper form). The WS Form B-82 is never mailed or reported electronically.

1.8.2 WS Form B-91 (Monthly Reporting Form). If you are unable to use electronic reporting, then you need to use the WS Form B-91 'Record of River and Climatological Observations' to document the month of daily observations and then submit the completed Form B-91, to the NWSREP at the beginning of the new month.

DATE \_\_\_\_\_, 20\_\_\_\_ DAY OF WEEK \_\_\_\_\_

TEMPERATURE °F			PRECIPITATION																							
24 Hrs. ending at Observation		AT. OBSN.	DRAW A STRAIGHT LINE ( — ) THROUGH HOURS PRECIPITATION WAS OBSERVED, AND A WAVED LINE ( ~~~ ) THROUGH HOURS PRECIPITATION PROBABLY OCCURRED BUT WAS NOT OBSERVED.																							
MAX.	MIN.		A.M.												P.M.										Midnight	
			1	2	3	4	5	6	7	8	9	10	11	Noon	1	2	3	4	5	6	7	8	9	10		11
PRECIPITATION		SNOW, ICE PELLETS, HAIL, ICE on ground at Obsn. (Inches)	WEATHER						REMARKS AND NOTES																	
24 Hr. Amounts AT OBSN.			Mark "X" for all types that occur during the calendar day																							
RAIN, MELTED SNOW, Etc. (Inches and Hundredths)	SNOW, ICE PELLETS, HAIL (Inches and tenths)		Fog	Ice Pellets	Glaze	Thunder	Hail	Damaging Wind																		

ENTER ADDITIONAL NOTES ON REVERSE SIDE

Figure B-1. WS Form B-82, Observer’s Daily Notepad

The information on one page of WS Form B-82 is transferred to one line of WS Form B-91 (Figure B-2). For example, information for March 23rd on WS Form B-82 is transferred to the line designated for the 23rd day of the month on the WS Form B-91. Each page of WS Form B-91 contains rows for an entire month's observations.

Daily entries are recorded on the WS Form B-91 for the observational day (**24 hours ending at the official time of observation**) and not by calendar day (midnight to midnight). For example, for the observer who takes observations in the morning, the Maximum Temperatures (for nearly all days of the year) will appear on the official reporting form (i.e., WS Form B-91) as if shifted forward by one day.

The NWSREP will instruct you on how many copies of WS Form B-91 are required, and where to mail the copies. The forms should be mailed as soon as possible, but no later than the fifth day of the month.

If you inadvertently forgot to take an observation of a particular element (i.e., Current Temperature), then enter the letter ‘M’ to the appropriate column in the row the observation would have been logged.

Instructions for filling out the WS Form B-91 are contained on the cover pages of the form pad.

1.8.3 WS Form B-92 (Record of Evaporation and Climatological Observations). If you are unable to use electronic reporting, then you need to use the WS Form B-92 (Figure B-3) to document the month of daily observations and then submit the completed Form B-92, to the NWSREP at the beginning of the new month.

U.S. DEPARTMENT OF COMMERCE  
NATIONAL OCEANIC AND ATMOSPHERIC ADMINISTRATION  
NATIONAL WEATHER SERVICE

**WS FORM B-91  
(12/00)**

**RECORD OF RIVER AND CLIMATOLOGICAL OBSERVATIONS**

STATION (Climatological) Your Station		COUNTY Your County		MONTH Sample 20 02		RIVER Your River	
STATE Your State		PRECIPITATION GP		STANDARD TIME IN USE E		NORMAL POOL STAGE Ft.	
TIME (local) OF OBSERVATION 7A		ELEVATION OF RIVER GAGE ZERO 836.37 Ft.		PRECIPITATION GP		PRECIPITATION GP	
TYPE OF RIVER GAGE Wire-weight		TEMP GP		FLOOD STAGE B		FLOOD STAGE B	
TEMPERATURE F		24 HR. AMOUNTS		PRECIPITATION		WEATHER (Calendar Day)	
AT OBSN.		At Ob.		Draw a straight line (---) through hours precipitation was observed (dots) (.....) through hours precipitation probably occurred (indashed).		Mark "x" for all types occurring each day	
24 HRS ENDING AT OBSERVATION		Snow, ice pellets (fms and tenths)		A.M.		Fog	
MAX		Snow, ice pellets (fms and tenths)		NOON		Ice Pellets	
MIN		Snow, ice pellets (fms and tenths)		P.M.		Glaze	
DATE		Snow, ice pellets (fms and tenths)		1 2 3 4 5 6 7 8 9 10 11 12		Thunder	
1		Snow, ice pellets (fms and tenths)		1 2 3 4 5 6 7 8 9 10 11 12		Hail	
2		Snow, ice pellets (fms and tenths)		1 2 3 4 5 6 7 8 9 10 11 12		Dancing Winds	
3		Snow, ice pellets (fms and tenths)		1 2 3 4 5 6 7 8 9 10 11 12		Time of observation if different from above	
4		Snow, ice pellets (fms and tenths)		1 2 3 4 5 6 7 8 9 10 11 12		CONDITION	
5		Snow, ice pellets (fms and tenths)		1 2 3 4 5 6 7 8 9 10 11 12		GAGE READING AT	
6		Snow, ice pellets (fms and tenths)		1 2 3 4 5 6 7 8 9 10 11 12		7 A.M.	
7		Snow, ice pellets (fms and tenths)		1 2 3 4 5 6 7 8 9 10 11 12		TENDANCY	
8		Snow, ice pellets (fms and tenths)		1 2 3 4 5 6 7 8 9 10 11 12		REMARKS (Special observations, etc.)	
9		Snow, ice pellets (fms and tenths)		1 2 3 4 5 6 7 8 9 10 11 12			
10		Snow, ice pellets (fms and tenths)		1 2 3 4 5 6 7 8 9 10 11 12			
11		Snow, ice pellets (fms and tenths)		1 2 3 4 5 6 7 8 9 10 11 12			
12		Snow, ice pellets (fms and tenths)		1 2 3 4 5 6 7 8 9 10 11 12			
13		Snow, ice pellets (fms and tenths)		1 2 3 4 5 6 7 8 9 10 11 12			
14		Snow, ice pellets (fms and tenths)		1 2 3 4 5 6 7 8 9 10 11 12			
15		Snow, ice pellets (fms and tenths)		1 2 3 4 5 6 7 8 9 10 11 12			
16		Snow, ice pellets (fms and tenths)		1 2 3 4 5 6 7 8 9 10 11 12			
17		Snow, ice pellets (fms and tenths)		1 2 3 4 5 6 7 8 9 10 11 12			
18		Snow, ice pellets (fms and tenths)		1 2 3 4 5 6 7 8 9 10 11 12			
19		Snow, ice pellets (fms and tenths)		1 2 3 4 5 6 7 8 9 10 11 12			
20		Snow, ice pellets (fms and tenths)		1 2 3 4 5 6 7 8 9 10 11 12			
21		Snow, ice pellets (fms and tenths)		1 2 3 4 5 6 7 8 9 10 11 12			
22		Snow, ice pellets (fms and tenths)		1 2 3 4 5 6 7 8 9 10 11 12			
23		Snow, ice pellets (fms and tenths)		1 2 3 4 5 6 7 8 9 10 11 12			
24		Snow, ice pellets (fms and tenths)		1 2 3 4 5 6 7 8 9 10 11 12			
25		Snow, ice pellets (fms and tenths)		1 2 3 4 5 6 7 8 9 10 11 12			
26		Snow, ice pellets (fms and tenths)		1 2 3 4 5 6 7 8 9 10 11 12			
27		Snow, ice pellets (fms and tenths)		1 2 3 4 5 6 7 8 9 10 11 12			
28		Snow, ice pellets (fms and tenths)		1 2 3 4 5 6 7 8 9 10 11 12			
29		Snow, ice pellets (fms and tenths)		1 2 3 4 5 6 7 8 9 10 11 12			
30		Snow, ice pellets (fms and tenths)		1 2 3 4 5 6 7 8 9 10 11 12			
31		Snow, ice pellets (fms and tenths)		1 2 3 4 5 6 7 8 9 10 11 12			
SUM		Snow, ice pellets (fms and tenths)		CHECK BAR (For wire-weight) NORMAL CK. BAR			
CONDITION OF RIVER AT GAGE		READING		DATE		OBSERVER Your Name	
A. Obstructed by rough ice.		22:10		Last Day of Precipitous Month		SUPERVISING OFFICE	
B. Frozen, but open at gage.		22:10		15th of Month		Name of HSA, WSO, W5FO	
C. Upper surface of smooth ice.		22:19		Last Day of Month		STATION INDEX NO	
D. Ice gorge above gage.						Enter Your Index Number	

Figure B-2. WS Form B-91 – Example of Temperature and Precipitation Entries

Station		County		State		Date (Month & Yr.)		Time of Complete Observation (Local time)		Standard Time in Use		RECORD OF EVAPORATION AND CLIMATOLOGICAL OBSERVATIONS								
AIR TEMPERATURE °F												WIND		EVAPORATION		WATER TEMP. °F		ADDITIONAL DATA/REMARKS		
24 Hours Ending at Observation		At Observation		Supplemental Readings of		24 Hour Amounts		At Obsn.		Anemometer		Gage Reading or Amount Added		Reading (When Tank Filled or Amount Removed)		24 Hours Ending at Observation				
Max.	Min.	Dry-bulb	Wet-bulb	Dew Point	Dry-bulb	Wet-bulb	Dew Point	Rain, Melted snow, etc. (in hundredths)	Snow, Ice Pellets, Hail (in. & tenths)	Time of beginning	Time of ending	Time of beginning	Time of ending	Reading	Amount	Max.	Min.			
1																				
2																				
3																				
4																				
5																				
6																				
7																				
8																				
9																				
10																				
11																				
12																				
13																				
14																				
15																				
16																				
17																				
18																				
19																				
20																				
21																				
22																				
23																				
24																				
25																				
26																				
27																				
28																				
29																				
30																				
31																				
Sum.																				
Avg.																				
U.S. DEPARTMENT OF COMMERCE NOAA NATIONAL WEATHER SERVICE												Adjusted Total				STATION NUMBER				

Figure B-3. WS Form B-92 – Record of Evaporation and Climatological Observations

FORM 1009-ST - **RECORD OF SOIL TEMPERATURE OBSERVATIONS** -  
 U.S. Dept. of Commerce - NOAA - NWS

STATION NAME <b>IWX</b>		MONTH		YEAR		OBSERVER		STATION INDEX NUMBER																
STATE <b>INDIANA</b>		COUNTY: Kosciusko		STANDARD TIME IN USE <b>E</b>		SUPERVISING NWS OFFICE																		
DATE	8 A.M.							5 P.M.							Max/Min 24 hrs ending at _____ (if so equipped)									
	2 in.	4 in.	8 in.	20 in.	40 in.	60 in.	Surface Cover	2 in.	4 in.	8 in.	20 in.	40 in.	60 in.	Surface Cover	Max 1 in.	Min 1 in.	Max 2 1/4 in.	Min 2 1/4 in.	Max 4 in.	Min 4 in.	Max 8 in.	Min 8 in.	Surface Cover	
1																								
2																								
3																								
4																								
5																								
6																								
7																								
8																								
9																								
10																								
11																								
12																								
13																								
14																								
15																								
16																								
17																								
18																								
19																								
20																								
21																								
22																								
23																								
24																								
25																								
26																								
27																								
28																								
29																								
30																								
31																								

Figure B-4. WS Form 1009-ST – Record of Soil Temperature Observations

1.8.4 WS Form 1009-ST (Record of Soil Temperature Observations). If you are unable to use electronic reporting, then you need to use the WS Form 1009-ST (Figure B-4) to document the month of daily observations and then submit the completed WS Form 1009-ST, to the NWSREP at the beginning of the new month.

## 2. PRECIPITATION MEASUREMENTS

2.1 Liquid Precipitation. There are two basic types of precipitation; liquid and solid. Liquid precipitation includes rain and drizzle. Since precipitation, by definition, falls to the ground, dew (which forms on surfaces) is not precipitation. Frozen precipitation includes snow, hail, ice pellets (sleet), snow pellets, ice crystals, and other types. Precipitation is measured in terms of its accumulation:

- a. Liquid (including the water content of frozen precipitation which has melted) precipitation is measured to the nearest hundredth of an inch.
- b. Frozen precipitation is measured to the nearest tenth of an inch.

2.1.1 Four-Inch Non-Recording Gauge. The four-inch clear plastic gauge is read directly from the gradations and numerals visible along measuring tube. The reading is taken from the bottom of the meniscus. The meniscus is the concave shape the water surface makes due to water's adhesion to the wall of the tube. The edge of the meniscus extends several hundredths of an inch higher than the level of the water.

Therefore, lift the tube to eye level so the meniscus is even with your eyes, hold the tube vertical, and then read the index marks on the tube that are level with the bottom of the concave meniscus. The measuring tube holds up to one inch of water. If more than an inch of rain fell, then discard the water from the measuring tube (i.e., one inch) and pour the water from the overflow cylinder into the measuring tube. The overflow cylinder's capacity is 11.30-inches.

Measure the additional water you poured into the measuring tube and add this number to the one inch amount already discarded. This should be repeated until all rainwater is measured out of the overflow cylinder. When finished, place the measuring tube back inside the overflow cylinder and place back the funnel.



Figure B-5. Four-Inch Plastic Gauge



Figure B-6. Removing the Measuring Tube



Figure B-7. Reading the Measuring Tube at Eye Level





Figure B-8. Eight-Inch Gauge



Figure B-9. Removing the Funnel



Figure B-10. Removing the Measuring Tube

2.1.2 Eight-Inch Non-Recording Gauge. This gauge is also known as the eight-inch Standard Rain Gauge (SRG). The Observer removes the funnel from the top of the Measuring Tube and removes the tube from the overflow can, and then places the calibrated measuring stick into the tube to read the precipitation amount (Figure B-13).

Slide the stick into the gauge, **do not bounce**, and leave it in place for two or three seconds. The tube holds up to two inches of liquid precipitation. The water will coat the stick. Remove the stick and read the rainfall amount from the top of the coated part of the stick. Replacement sticks are available from the National Weather Service Representative (NWSREP).

For amounts of more than 2 inches, when the measuring tube has spilled over into the overflow can, carefully remove the funnel and empty the measuring tube to avoid spilling water back into the overflow can. Allow a few seconds for all the water to drain from the tube.



Figure B-11. Dipping the Measuring Stick



Figure B-12. Measuring the Precipitation

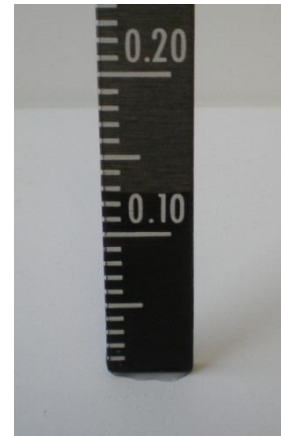

Figure B-13. Reading the Precipitation Amount

Place the funnel over the measuring tube (Figure B-9) and pour the water from the overflow can into the measuring tube. Measure this amount and add it to the two inches already emptied. This procedure should be repeated if necessary.

2.2 Freezing Precipitation. The Eight-Inch Gauge and the Four-Inch Gauge will collect freezing precipitation. If the ice that accretes on the surfaces of the funnel and overflow can is thick enough to be measured (i.e., one tenth of an inch), then you may report the thickness of the ice accretion (i.e., glaze).

There is no requirement to report the thickness of the accreted ice however you may report the thickness in tenths of an inch with the use of the 20-inch snow stick.

The thickness should be reported in the Remarks Field of the reporting form. Also remember to select 'Glaze' from the Weather Phenomenon categories when you report the thickness of the ice.

2.3 Frozen Precipitation. Frozen precipitation includes snow, ice pellets, and hail. Observers should be familiar with the official policy in the, *Snow Measurement Guidelines for NWS Cooperative Observers*. It is posted online on: [www.weather.gov/om/coop/training.htm](http://www.weather.gov/om/coop/training.htm).

Four types of snow measurements are reported:

- a. Snowfall
- b. Snow Depth
- c. Snowfall Water Content
- d. Snow Depth Water Content

A snow measuring video is also available online, [www.weather.gov/om/coop/training.htm](http://www.weather.gov/om/coop/training.htm), as a 22-minute video produced by the Department of Atmospheric Science at Colorado State University. This same video can be ordered as a DVD by your NWSREP.

2.3.1 Snowfall (New Snow). The Snowfall observation is the greatest amount of snowfall that has accumulated on your snow measurement board (SMB) since the previous snowfall observation. This measurement should be taken at least once per day at the time of the standard observation, unless requested otherwise.

Use the NWS issued snow stick and snow measurement board. Site the Snow Measuring Board (SMB) in a level area where wind effects and drifting are minimized and far enough away from buildings or trees where snow blowing off of higher structures is unlikely to fall on your SMB.

For guidance on taking the snowfall observation, see the *Snow Measurement Guidelines*. It is found in Other Resources section on website: <http://www.nws.noaa.gov/om/coop/training.htm>.

Because of evaporation or drifting, the board may need adjusting daily to ensure that the top of the board remains flush with the old snow.

Note: No matter how many times it snows during the 24 hour period report only the single highest snowfall amount that accumulated on the snow measurement board. Clear the snow board only once, at the end of the 24 hour observing period.



Figure B-14. Snow Measurement Board

For weather events in which all snow melts upon contact as it lands, enter the word, *Trace*, in the snowfall column. In the remarks section report, “Snow melted as it landed.”

2.3.1.1 Snow Measurement Stick. Specially designed snow measuring sticks are available from the NWSREP. Figure B-15 and B-16, illustrate the two sizes. The 20-inch measuring stick is standard equipment for areas that climatologically receive limited amounts of snow; and the 40-inch stick is required for sites that receive the greatest accumulations.



Figure B-15. 40-Inch and 20-Inch Snow Sticks



Figure B-16. Snow Sticks Measure in Tenths of an Inch

2.3.2 Snow Depth. Snow Depth is the total depth of snow (including any ice) on the ground at the normal observation time. The snow depth includes new snow that has fallen combined with snow already on the ground, see Figure B-17.

**Note:** When snow falls between observation times, even if it is expected to melt before the next observation time, measure its greatest depth on the snow board or if the ground was bare at the start of the observation period, measure the greatest depth on the ground. Do not report this measurement as *snow depth*, even if measured from the ground. This is a *snowfall* measurement to be noted and reported as the *snowfall* observation of record, if it was determined to be the greatest snowfall amount measured in the 24 hours.

For procedures on taking the snow depth observation, see *Snow Measurement Guidelines*. It is found on the website, <http://www.nws.noaa.gov/om/coop/training.htm>, under the Other Resources section.

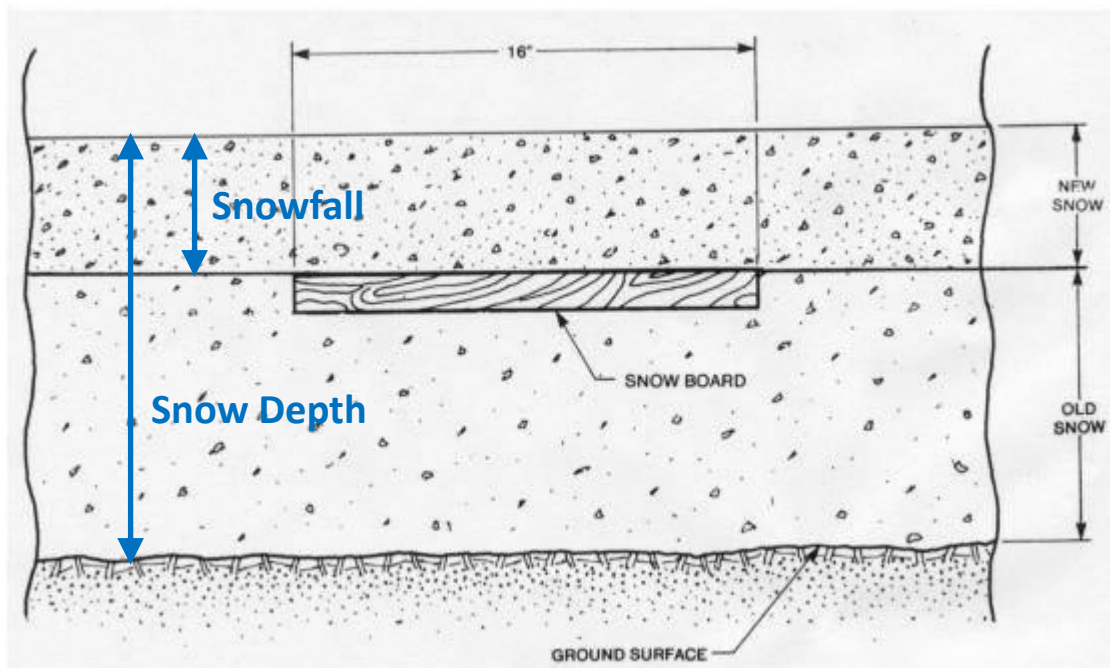

Figure B-17. Snow Measurement Board Upon Old Snow

**Note:** The NWS provided snow board (Figure B-14) is usually the best surface to measure snowfall. It measures 16 inches by 24 inches, is eight millimeters thick, and is made of expanded PVC. These snow boards are available from your NWSREP.

If a snow board is unavailable, and if the old snow has settled or partially melted enough to develop a crust or to be noticeably denser than the new snow, it may be possible to insert a snow stick until it meets the greater resistance of the crust of old snow, and to use this depth as the amount of new snow that fell.

Sometimes pollution or dust will give the old snow a darker color than the new snow. If so, cut a vertical core through the snow down to the ground. Measure the new (whitest) snowfall to the nearest tenth of an inch, and the total snow depth to the nearest inch.

2.3.2.1 Snow Depth Stakes. Snow stakes are routinely used in geographical areas subject to deep snow accumulations. Stakes are graduated in whole inches, with numerals inscribed at two inch intervals.

Stakes are sturdy, water-resistant, and painted white to minimize snow melt around them. The example illustrated in Figure B-18, is a Three Foot Snow Stake.

The Snow Stake is available in two other sizes, for deeper snow conditions: five foot snow stake, and the ten foot snow stake.

Measurements from Snow Stakes are reported as ‘snow depth.’



Figure B-18. Snow Depth Stake

If possible, the stake should be located on level ground where the snow depth is typical of the area. In hilly areas, select a northerly exposure in a level area if possible. The area around the stake should be free from trees, buildings and other obstructions that could seriously affect the wind flow around the stake. Low, leafless bushes, however, can be beneficial in reducing drifting. If possible, several snow stakes may be used to represent the snow depth.

2.3.3 Snowfall Water Content. Measure the water content of new snowfall since the previous day’s observation in accordance with the procedures Section 4.1, in the *Snow Measurement Guidelines*. It is found on the website, <http://www.nws.noaa.gov/om/coop/training.htm>, under the Other Resources section.

2.3.4 Snow Depth Water Content. The water content of new and old snow on the ground is measured by taking a core sample. Runoff from winter snow pack has the potential to produce flooding during warm spells or spring thaw. Measurement of the snow depth water content helps the NWS to forecast river stages and flooding potential during rapid runoff.

Measure the snow depth water content in accordance with procedures in Section 4.2, of the, *Snow Measurement Guidelines*. It is found in <http://www.nws.noaa.gov/om/coop/training.htm>, in the Other Resources section.

## 2.4 Reporting Precipitation Observations.

2.4.1 Rainfall Reporting. Rainfall is reported in the hundredths of an inch. Enter this observation once per day in the WxCoder column marked, “Rain, melted snow.”

2.4.2 Snowfall Reporting. Snowfall is reported in tenths of an inch. Enter this observation (the maximum amount of snow measured in 24-hours) once per day in the WxCoder column marked, ”24-Hr Amounts: Snow, ice pellets, hail.”

2.4.3 Snow Depth Reporting. Snow depth is reported in whole inches. Enter this observation in the WxCoder in the column marked “Snow, Ice pellets, Hail, Ice, on Ground.”

2.4.4 Snowfall Water Content Reporting. Snowfall water content is reported in hundredths of an inch. Enter this observation in the WxCoder in the column marked ‘Rain, melted snow.’

2.4.5 Snow Depth Water Content Reporting. Snow depth water content is reported in hundredths of an inch. Enter this observation in the column titled, ‘Remarks’ in WxCoder.

Note on Hail and Sleet: If any Hail or Sleet has accumulated on the ground, then measure it in the same manner as snowfall, in tenths of inches and log to WxCoder (or form) in the column marked ’24-Hr Amounts: Snow, ice pellets, hail.”

If the accumulated hail were deep enough (or weather cold enough) to preserve the Hail or Sleet accumulation to the time of the standard hour of observation, then report the depth of Hail or Sleet to the Snow Depth column rounding to nearest whole inch.

If less than half an inch, then report a T, for Trace. Make sure you write into the Remarks Field of your logging form, “**Accumulation on ground is from Hail.**” Or if from sleet: “**Accumulation on ground is from Sleet.**”

## 2.5 Recording Gauges.

2.5.1 Reporting Gauge Problems and System Outages. The Observer phones or emails the NWSREP as soon as an FPR problem is discovered. The display should never give a negative value.

The Observer should not allow the bucket to reach capacity (i.e., 20 inches of equivalent rain) as seen on the FPR display. The Observers should phone or email the NWSREP when the display reads more than 15.00 inches (bucket capacity is 20 inches). This way the NWSREP can schedule a visit to drain the rain gauge.

Update the *FPR Log Sheet*, on hard copy, to account for when the bucket level is observed greater than 15.00 inches, or if any error messages have appeared. Mail the NWSREP the *FPR Log Sheet* to document any maintenance actions you have taken in the days and weeks prior to the data download.

**2.5.2 FPR-D (Sutron) Precipitation Data Reporting.** In the first five days of each month, but never before 12am on the first day of month, and at a time when it is not raining or snowing, retrieve the precipitation measurements from the FPR-D gauge. This outdoor procedure might take 5 minutes.

Access to the FPR-D data port is illustrated in Figures B-19, B-20, and B-21, below.

Instructions for the observer to email the monthly FPR-D data to the NWSREP can be found at: <http://www.nws.noaa.gov/ops2/Surface/coopimplementation.htm>. Select the document, “*FPR-D Observer Instructions*.”



Figure B-19. FPR-D Recording Rain Gauge



Figure B-20. FPR-D Data Logger



Figure B-21. Insert SD Memory Card to Download Last 60 Days

**2.5.3 FPR-E (CES) Precipitation Data Reporting.** In the first five days of each month, but never before 12am on the first day of month, and at a time when it is not raining or snowing, retrieve the precipitation measurements from the FPR-E gauge. This outdoor procedure might take 15 minutes.

Access to the FPR-E data port is illustrated in Figures B-22, B-23, and B-24, below.

Instructions for the observer to email the monthly FPR-E data to the NWSREP can be found at:

<http://www.nws.noaa.gov/ops2/Surface/coopimplementation.htm> . Select the document, “*FPR-E Observer Instructions*.”



Figure B-22. FPR-E Recording Rain Gauge



Figure B-23. FPR-E Data Logger



Figure B-24. Insert Flash Drive to Download Last 100 Days

2.5.4 Fischer-Porter Mechanical Gauge Upkeep and Reporting. Once per month open the door on the lower casing and remove the punched paper tape from the take-up reel. Refer to Figure B-25. Mail this punch tape to the WFO for the attention of your NWSREP.

- a. Inspect the gauge weekly to ensure that the tape is positioned at the proper time. The red numerals on the left side of the tape indicate the days. Make a dial reading and enter it on the tape. If the time indicated on the tape is in error by more than an hour (4 spaces) from local time, reset it to the correct time. Annotate the time correction on the tape. Refer to Section 2.5.5.4, of this manual for instructions on setting the tape to the correct time. Do not force manual punches before adjusting or removing the tape.
- b. If previous arrangements have been made with your NWSREP, then read the dial indicator to understand the level of collected liquid in the bucket. When the accumulated fluid in the bucket is 15 inches or greater (i.e., 5 inches past one full revolution of the dial), remove the upper hood. Unhook the plastic drain tube from the brim of the collector bucket and lower the tube into a multi-gallon container. The container should collect the fluids and retained for pick up as instructed by the NWSREP. In warmer weather, add oil to the bucket.

Write the date and time on the tape along with a note indicating the bucket had been emptied, and that oil/propylene glycol has been added. Your NWSREP may ask you to store several containers of propylene glycol and oil.

**Note:** Never attempt to remove or replace the bucket without first draining the bucket fluids into multi-gallon container. Consult with your NWSREP if you require assistance.

- c. For winter operation, refer to Section 2.5.4.3, and follow instructions to remove funnel, empty bucket, add propylene glycol, and add oil to the bucket. To prevent accumulating liquid from freezing and risking damage to bucket, you add



propylene glycol as bucket levels rise. Add propylene glycol each time your dial indicator reads 3.5 inches, 7.0 inches, 10.5 inches, and 14.0 inches (i.e., 4 inches past one full revolution of the dial). Maintain the concentration specified in Table B-1 (Section 2.5.4.3).

- d. As soon as possible after the beginning of each month, remove the punched portion of the tape from the black take-up spool. Before removing the tape, draw a line along the top of the punch block for a gauge time versus local time reference. Annotate the tape with station name and number, date and time information as instructed.

Advance the tape to provide 20 inches of blank tape following the punched portion. Tear or cut the tape above the punch block and remove by slipping it off the end of the black take-up spool. Include any other information that may be helpful in processing the tape.

- e. Check the amount of tape remaining on the spool. Install a new roll of tape when necessary. Thread the loose end of the tape from the supply roll under the tension spring, through the punch block behind the guide bar, and onto the take-up spool. The printed side of the tape should face you and be properly threaded through the punch block and paper guides.
- f. Set the tape to the correct time (Section 2.5.5.4) and mark the station name, station number, start time, date and month on the tape.
- g. Remove, empty, and replace the Chad tray.
- h. Close and fasten the door with both latches to keep out dust and moisture. Insert the latch cover in its retainer on the base of the gauge. The slot near the top should be over the padlock eye on the hood. The latch cover need not be installed if it is not necessary to lock the gauge.
- i. Put the punched tape for the past month in one of the pre-addressed mailers and mail to the Weather Forecast Office by the 5<sup>th</sup> of the month.

2.5.4.1 Bucket Draining. The empty bucket has the capacity for 22 inches of rainfall (or 4.9 gallons). Read the gauge display weekly during rainy periods, to anticipate the date to drain the bucket. If the display reading exceeds 15.00 inches, drain the bucket. Write down onto the Punch-Tape, the date of bucket draining and the new level that is in the bucket after servicing.

2.5.4.2 Summer Maintenance. Remove the cone-shaped hood and inspect the contents of the bucket with a mixing stick (i.e., paint stirrer). Remove and properly dispose of any leaves or debris that might have collected when the funnel was removed at start of winter season. Then with the stick, ensure there is still a ¼ inch film of oil on the surface to inhibit evaporation.

If the bucket is near or exceeds 15 inches (i.e., 5 inches past one full revolution of the dial) on

the day you are installing the funnel then perform a partial draining of the bucket by keeping the oil from running out the drain tube. Add propylene glycol if local conditions require. Drain the contents into a multi-gallon container.

Install the funnel: Remove the cone-shaped hood, turn it upside down, and fasten the funnel by rotating its three slots onto the three pins of the cone-shaped hood. Return this hood to gauge.

2.5.4.3 Winter Maintenance. During the season when frozen precipitation or freezing temperatures are likely to occur; recording gauges need to be winterized, as described below:

- a. Remove funnel: Remove the cone-shaped hood tip it upside down and set it down. Rotate the funnel so its slots allow it to slide free from the three pins located on the base of the hood assembly.
- b. Empty the collection bucket by unhooking the top end of the drain tube and placing the end into a multi- gallon container. **Caution:** Do not attempt to lift a full bucket by yourself, because it can weigh 40 pounds.
- c. Return the empty bucket to its regular position to ready the bucket for its charge of propylene glycol. Following the propylene glycol you will add one half quart of oil. Do not use commercial anti-freeze and do not add water.
- d. Initial charge: Into the empty bucket, pour an amount of food grade propylene glycol as specified by one of the three temperature categories listed in this table. Choose the category that offers protection against the coldest condition possible for the site. Make an initial charge of 1.0 quart of propylene glycol if the coldest the site could get is 15°F.

Coldest Temperature	Initial charge and subsequent charges of food grade propylene glycol (PG). When bucket equivalent levels reach 3.5-inches, 7.0-inches, 10.5-inches, and 14.0-inches, add this amount of PG.	To Maintain this Concentration
+ 15° F	1.0 quart	25%
0° F	1.5 quarts	35%
- 30° F	2.0 quarts	50%

Table B-1. Propylene Glycol Schedule for Extreme Cold Sites

Note: Two quarts of propylene glycol increase height of liquid by just one inch.

- e. Subsequent Charges: When visual inspection of display shows the bucket level has reached 3.5 inches add the specified amount of propylene glycol; for example the coldest category sites (-30°F) require two quarts be added. Always add the same amount as the initial charge. If you had not serviced the bucket at either 3.5

inches, or 7.0 inches, or 10.5 inches and now notice the bucket holds 11 inches, take action to drain the bucket. Recharge the empty bucket with at least two quarts of propylene to ensure the first 3.5 inches of precipitation (liquid equivalent) has 50% concentration. To prevent the bucket contents from ever freezing, add propylene glycol per the schedule in the above table at 3.5, 7.0, 10.5, and 14.0 inches.

- f. Add a half a quart of oil after the initial charge of propylene glycol. For sites more prone to evaporation, these include tropical sites and sites with windy conditions with low relative humidity; ensure a film of oil is visible after draining water/propylene glycol mixture. Use NWS supplies, only.

Further Considerations: If bucket is emptied of all contents, then charge with one half quart of oil. You do not need more than ¼ inch surface oil layer in the Fischer-Porter's 14 inch diameter bucket. Snowfall and high-rate rainfall events can lead to a layer of snow, ice, or fresh rainwater that rests on top of the oil layer. For these events stir the bucket with a mixing stick. This will prevent freezing and possible equipment damage.

- g. Make no adjustments to the gauge after propylene glycol and/or oil has been added.
- h. Document the date and hour each time the bucket was charged with propylene glycol and/or oil. For legacy gauges mark the paper tape with a brief note (i.e., added propylene glycol and/or oil at 2pm March 16, 2010). Write this information down onto the same Punch Tape that has recorded the discontinuity.

2.5.4.4 Setting the Punch Tape to the Correct Time. The electronic timer will trigger the gauge to punch every 15 minutes. Ensure the power switch is set "ON." The best time to change the tape is immediately after a routine punch. This will allow 15 minutes to change the tape without missing any readings. The Model III timer has two buttons and a window on the front face. The window allows the observer to see the LED timer. The right button is pressed to light the LED while the left button is pressed to advance the time. The timer should be set to the number of minutes past the last scheduled punch time.

Set the tape to the correct time, as follows:

- a. With the power switch "OFF," feed the tape through the punch block onto the take-up spool. Continue feeding the tape until the first time line to appear above the punch block reads two hours before the current time.

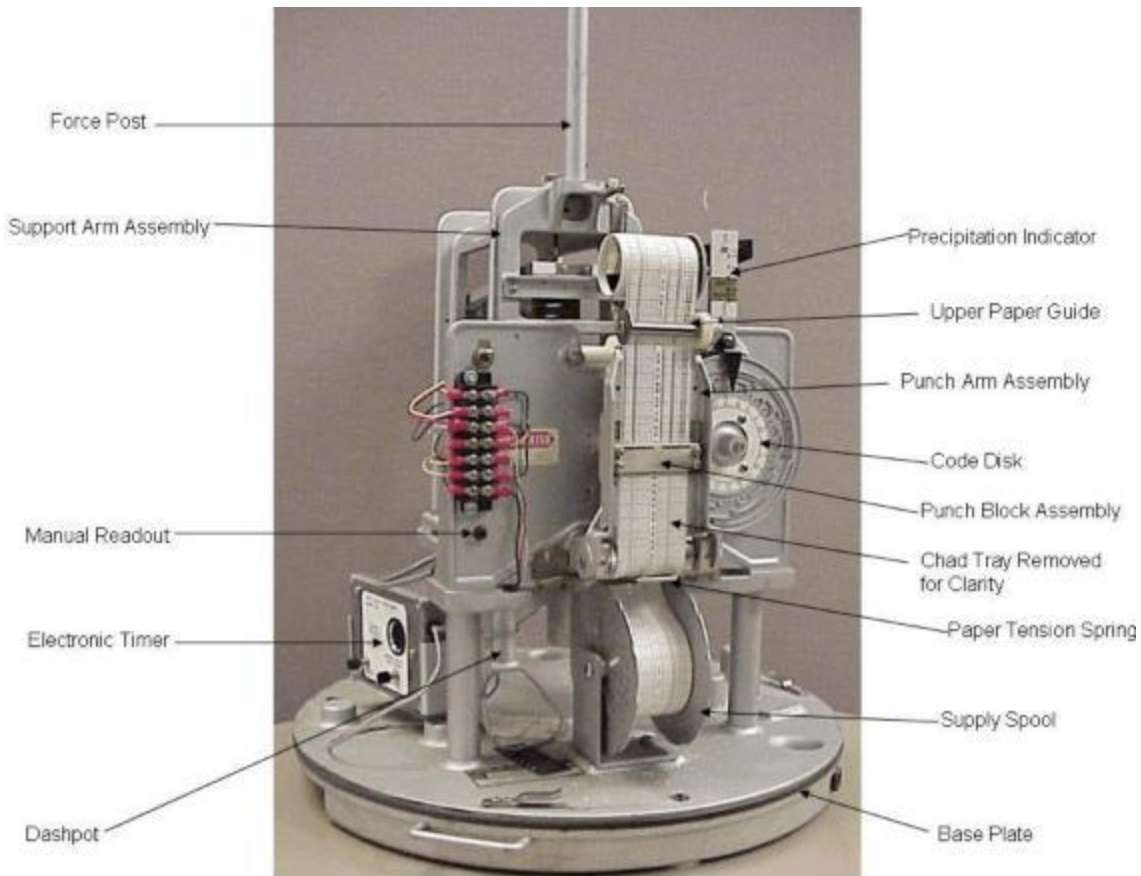

Figure B-25. Recorder Components of Fischer-Porter Mechanical Gauge – Casing Removed

- b. Turn the power switch to the “ON” position and push the button to advance the tape eight punches or until the time line on the tape corresponding to the next 15-minute time interval is lined up with the holes in the punch block. Next, draw a line across the tape just above the punching block, using a felt tip pen. Write the date and time on the tape above the punch block. This reference will determine the actual start of the record. The next punch should occur at the next 15-minute clock interval and it should agree with the time shown by the tape within 15 minutes. Hold the button down 5 seconds for each punch.

2.5.5. Consumable Supplies. These quantities will vary as a function of the amount of precipitation a site receives in a given season. Always contact your NWSREP if you are responsible for keeping any of these items ready for your Fischer-Porter recording rain gauge.

- a. One quart of oil (ASN Part 014-O-15)
- b. Four 2-quart containers of Propylene Glycol (ASN Part D111-153)
- c. One 5-gallon sealable plastic container available to discard bucket fluids

### 3. AIR TEMPERATURE MEASUREMENTS

3.1 Reading and Resetting the MMTS and Nimbus Temperature Displays. There are two types of instruments approved at cooperative stations; the liquid in glass (LIG) maximum and minimum thermometers, and the electronic thermometers. The electronic thermometers have two major types of displays: MMTS-1 and NIMBUS.

3.1.1 Operation. If no buttons are pressed, then the current temperature is displayed.

To view the Maximum or Minimum Temperature:

- a. **MMTS:** Depress the “MAX” button to display the maximum temperature that occurred since the unit was last reset. Depress the “MIN” button to do the same for the minimum temperature.
- b. **Nimbus:** Ensure the “MEMORY” switch is “OFF”. Depress and hold the “RECALL” button. The display will continue to toggle back and forth showing the maximum and minimum temperatures as long as the button is depressed. These are the maximum and minimum temperatures since this display unit was last reset.



Figure B-26. MMTS Control Buttons



Figure B-27. Nimbus Control Buttons

After recording the readings, then reset the Maximum Temperature and Minimum Temperature according to these procedures:

- a. **MMTS:** Simultaneously press the “RESET” and “MAX” buttons to reset the stored maximum temperature. Do the same with the “RESET” and “MIN” buttons to reset the minimum temperature.
- b. **Nimbus:** Ensure the “MEMORY” switch is “OFF”. Depress and hold the “CLEAR” button until the display reads “E2E2”. This takes about 6 seconds. Then release the button.

**Caution:** Do not reset the maximum or minimum temperatures between the scheduled times of observation. Resetting the temperatures at unscheduled times is a common cause of errors.

3.1.2 Convert Temperature to Whole Degrees. Electronic thermometers display in tenths of a degree, so take care to properly round the readings to whole degree. For temperatures warmer than 0° F (i.e., positively signed values) when the tenth’s digit is 5 or higher, round upward to the

nearest whole degree; and when the tenth's digit is 4 or lower, round downward to the nearest whole degree. For negatively signed temperatures (i.e., colder than 0°F) when the tenth's digit is 5 or lower, round toward zero.

Therefore, round the displayed temperature to whole units Fahrenheit by rounding all positively signed tenth's digit values 5 or more, upward (i.e., +3.5°F to 4°F), and all negatively signed tenth's digit values 5 or less, rounded toward zero (i.e., -3.5°F to -3°F).

Record the maximum, minimum, and current temperatures to the appropriate reporting system (or form) as instructed by your NWSREP.

**3.1.3 Identify and Correcting Erroneous Maximum/Minimum Temperatures.** Today's maximum temperature is at least as high as the higher of today's or yesterday's current temperatures at the time of their respective observations. For example, if the temperature at observation time yesterday was 64°, and today's maximum temperature is displayed as 62°, today's maximum temperature should be raised to 64°. See Section 3.6 for a description of the most frequently occurring errors.

Similarly, today's minimum temperature should be at least as low as the lowest of today's or yesterday's current temperature. If not, lower it to the lower of the two readings. For example, if yesterday's observation time current temperature was 64° and today's minimum is 65°, ensure the minimum temperature gets lowered to 64°. Improper resetting between observation times creates more errors than all other causes combined. Persistent errors from other causes (i.e., vibrations) should be reported to your NWSREP.

**3.1.4 Display Shows "Help".** If the "HELP" message appears on the display, press the "RESET" button to clear it and to show the current temperature.

- a. **MMTS:** When the AC power is interrupted to this model the microprocessor enters a "power down" condition in which the internal backup battery is used to preserve the maximum and minimum values stored in memory. These values are stored for at least two hours without power. **However, no updating of new maximum and minimum temperatures occurs during the power interruption.** Determine if the stored readings are still valid, based on the length of the outage.
- b. **Nimbus:** This unit does not display "HELP" as it continues full operation on either AC power or battery. It will operate for more than two weeks on a fresh battery in the absence of AC power.

**3.1.5 Digits in the Display are 'Blinking'.**

- a. **MMTS:** Blinking of the tenths (right-most) digit on the display indicates the internal backup battery is charging. If the blinking persists and is not caused by power outages, the battery is probably defective, and the NWSREP should be informed.

- b. **Nimbus:** An “L” blinking on the left side of the display indicates the battery is low and should be replaced. Replace it with a 9-Volt Alkaline battery. This unit does not recharge the battery.

3.2 Liquid in Glass (LIG) Thermometers. Thermometers are read and recorded to the nearest whole degree Fahrenheit. Temperatures below zero are recorded with a minus (–) sign to the left of the digits; i.e.,  $-15^{\circ}\text{F}$  for  $15^{\circ}\text{F}$  below zero.

The thermometers should be reset after they are read, as described in Sections 3.2.1, and 3.2.2 and Figure B-29. Record the maximum, minimum, and current temperatures as instructed by your NWSREP.

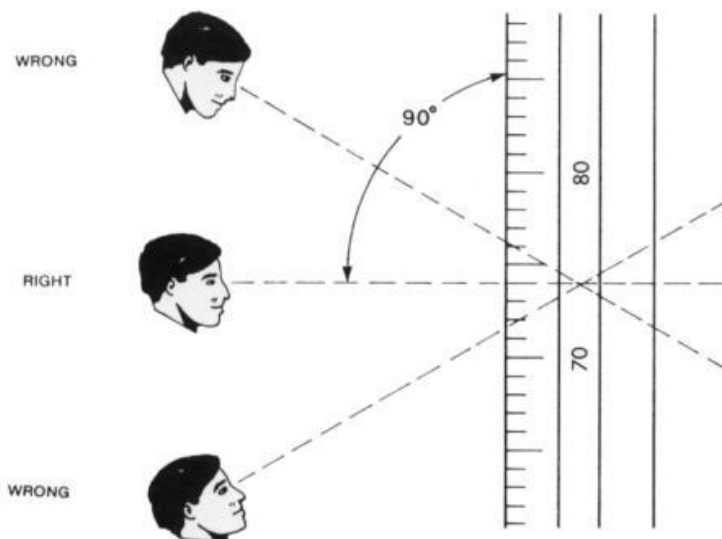

Figure B-28 Reading Thermometers

The line of sight from the top of the mercury or spirit column should be level to the eyes. If not, the reading will be too high or too low, as illustrated in Figure B-28.

**Caution:** Stand as far from the thermometers as possible to prevent body heat from changing the readings. This is particularly important in cold weather. The bulbs of the thermometer should not be touched.

3.2.1 Reading and Setting the Minimum Thermometer. The current temperature is the reading at the end of the spirit column. The current temperature is indicated where the bottom of the meniscus aligns to the marked gradations. The minimum temperature is the reading at the end of the index farthest from the bulb (not the reading on the spirit column). Read the thermometer in its nearly horizontal position before resetting.

To reset the minimum thermometer, point the bulb end upward (Figure B-30). Allow the index to fall to the end of the spirit column. Then turn the thermometer counterclockwise until it stops. The bulb end will now be slightly lower than horizontal.

3.2.2. Reading and Setting the Maximum Thermometer. The highest temperature occurring since the maximum temperature was previously reset is the reading at the top of the mercury column, taken with the bulb end lowered. Release the support catch on the back of the clamp and carefully lower the bulb end of the thermometer, then take the reading and record it. See Figure B-31.

To reset the maximum thermometer, start with the bulb end lowered and whirl it rapidly, allowing it to spin freely until it comes to rest. Repeat the spinning (whirling) if necessary until the mercury will not retreat farther into the bulb; i.e., until the column is no longer separated at or below the constriction. See Figure B-32.

Next, move the catch on the support until it touches the longer shaft. Carefully elevate the bulb end of the thermometer until the catch locks the shaft in place on the support. The thermometer is now “set” to indicate the maximum temperature that occurs before it is set again.

3.2.3 Reading the Current Temperature. Read the current temperature from the Minimum Thermometer before handling any of the instruments inside the CRS. Read the right-end of the alcohol column (not the index pointer). The current temperature is indicated where the bottom of the meniscus aligns to the marked gradations.

Refer to Figure B-29, for instructions on how to read and record temperatures from the Maximum and Minimum Thermometers.:



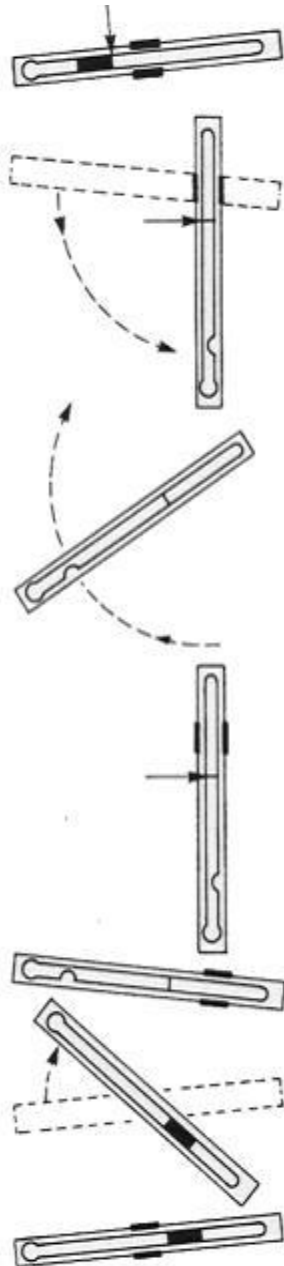

a. Read the right end of spirit column (red color) of the Minimum Thermometer. The meniscus is concave. The bottom of the meniscus is the value to read on the scale. Record this as the “At-Observation Temperature.”

b. Read the right end of index inside the Minimum Thermometer. Record this value as the Minimum Temperature of the observation.

c. Unlock and slowly lower Maximum Thermometer; read top of mercury column (silver color). Record this value as the Maximum Temperature of the observation.

d. Spin the Maximum Thermometer until its reading agrees (within 1°F) with reading at top of spirit column on Minimum Thermometer.

If the two thermometers cannot be made to agree within 1°F after spinning, this should be reported to your NWSREP.

e. Rotate the bulb-end to the left, to its nearly horizontal position, elevated 5° angle above horizontal. Lock the Maximum Thermometer in its ‘set position.’

f. Invert Minimum Thermometer until index drops to end of spirit column (red color).

g. Return Minimum Thermometer to its nearly horizontal position. The bulb end should make a 5° angle below the horizontal.

Figure B-29. Resetting the Maximum and Minimum Thermometers



Figure B-30. Minimum Thermometer – Vertical Position During Resetting



Figure B-31. Maximum Thermometer in Reading Position

3.2.4 Check the Difference Between the Max and Min Thermometers. On the Maximum Thermometer, read the temperature at the end of the mercury column farthest from the bulb immediately after resetting it, and compare that with the temperature at the end of the alcohol column in the Minimum Thermometer. The two readings should be within 1°F of each other. If they are not within 1°F notify your NWSREP. If you have touched the bulbs of either thermometer in the resetting process, step back, wait five minutes, and check again.

3.3. Correcting LIG Thermometer Errors. Sometimes there may be breaks in the mercury or spirit columns, the thermometer may be too difficult to reset, or it will reset itself between readings. The following instructions explain how to correct some of these problems. If a correction is impossible, the cooperative observer should request a replacement from the NWSREP.

3.3.1 Correcting Maximum Thermometers. The constriction shown in Figure B-32 may not be small enough in some thermometers to prevent the mercury from withdrawing into the bulb when the temperature falls after reaching its maximum value. Sometimes rough handling will cause this problem. To test for this defect, place the thermometer in a vertical position. If the mercury withdraws into the bulb without spinning the thermometer, replace the thermometer. This defect should be reported to the NWSREP promptly.

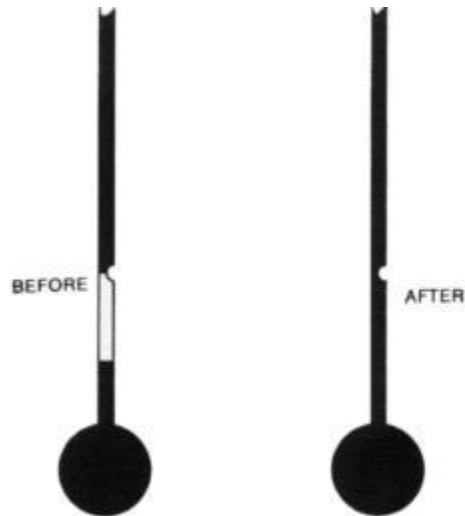

Figure B-32. Maximum Thermometer  
Before and After Spinning

If the constriction is too small, it may require many spins of the thermometer to get the mercury to return to the bulb, especially during low temperatures. If this occurs, then report to NWSREP.

Sometimes a small amount of mercury will lodge in the upper end of the bore. To correct this problem, hold the thermometer vertically with the bulb upward. Tap the metal back of the thermometer gently with a finger until the column joins the mercury at the bottom. Lower the bulb, allowing the column to slide slowly down the bore to the constriction. The tapping procedure is described in the next section, as Method I. When the mercury cannot be united as above, remove the thermometer from its support and swing it as in Method II of the next section.

**3.3.2 Correcting Minimum Thermometers.** Sometimes the spirit column of a minimum thermometer separates into small parts, causing incorrect readings. Separations may appear as small bubbles, making the column too long and readings too high, and trapping the index. Some spirits may separate completely and remain in the upper portion of the bore, resulting in readings too low. The thermometer should be inspected regularly for these problems. The methods described below may have to be repeated several times, taking 15 to 20 minutes, before the column can be joined.

The thermometer should be kept in a vertical position for several hours after parts of the column have been joined, in order that spirit clinging to the sides of the bore will drain down. When repeated attempts fail to join the spirit column, replace the minimum thermometer.

Vibration of the CRS and/or the thermometer mount can move the Index. Therefore, check that the Townsend mount and the CRS are firm and secure. Notify your NWSREP if they are not.

## METHOD I: TAPPING

Grasp the thermometer slightly below the middle with the bulb end down. Strike the edge of the metal back sharply against the palm of your hand as shown in Figure B-33. Repeat this procedure several times. Do not hold the thermometer so that your fingers or any part of your hand presses against the stem.

The bulb end may also be tapped on an open book.

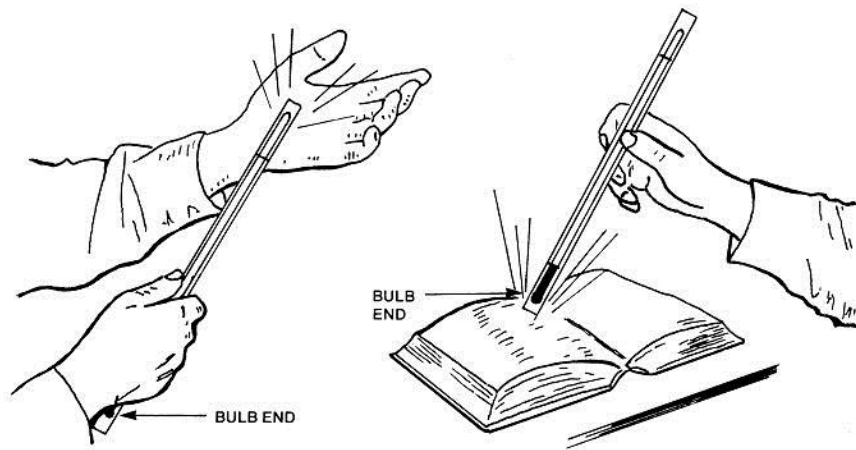

Figure B-33. Joining the Alcohol Column - Tapping Method

## METHOD II: CENTRIFUGAL FORCE METHOD

A short, quick swing of the arm is often effective in forcing the index toward the bulb and reuniting segments of the alcohol column. Grasp the thermometer firmly by the edges of the metal back a little above the midpoint. Avoid pressure on the back. With the arm extended upward, quickly swing the thermometer downward through an arc of 3 or 4 feet, stopping the motion suddenly when the thermometer is vertical. Sometimes it will be necessary to repeat this operation several times.

The thermometer can also be whirled on a short cord. Pass a strong cord through the hole in the top of the metal back of the thermometer. Firmly grasp the cord 6 to 8 inches from the thermometer and whirl it rapidly. Stand clear of all objects the thermometer might strike while whirling. It may take considerable practice to spin the thermometer rapidly and stop it safely. This method will often bring down an entrapped index and unite detached segments of the column. Ensure the cord is not cut by the thermometer back as it is whirled.

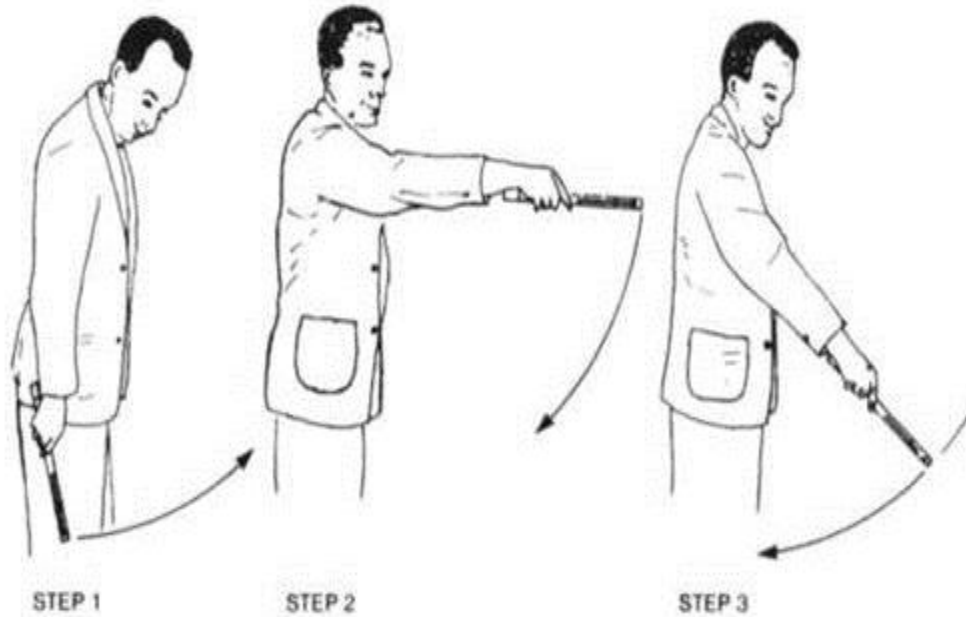

Figure B-34. Joining the Alcohol Column – Centrifugal Method

3.4 Mercury Clean-Up. Each cooperative observing site with mercurial thermometers should have one mercury clean-up kit for each mercury thermometer and a one printed Material Safety Data Sheet (MSDS).

Each observer should have been trained by their NWSREP on how to clean-up a mercury spill from a broken thermometer. If a mercurial thermometer breaks, there could be pieces of mercury contaminated glass and droplets of mercury on the floor of the CRS. When a broken thermometer is discovered, the observer should follow instructions provided with the kit.

If instructions are not provided, the following steps are recommended:

1. Wear safety glasses and gloves before starting the cleanup.
2. Collect any broken mercury contaminated glass and place it in the plastic bag. Be careful not to pierce the bag (double bagging may be necessary.)
3. Place the mercury absorbent sponge with rough-side up (the rough side contains active material that will amalgamate mercury).
4. Dampen the active side of the sponge with several drops of water. Spread the water evenly and wait one minute. (Excessive water may reduce the ability of the sponge to pick-up mercury.)
5. Slowly wipe down the mercury contaminated areas with the active side of the sponge (i.e., face down). The mercury droplets will be amalgamated by the chemical layer on the sponge.

6. Use the ‘mercury absorb powder’ to collect remaining mercury droplets, if necessary. Sprinkle powder and wet the powder with water and scoop the residue to a disposal bag.
7. Place the used sponge into the plastic bag, seal the bag closed with adhesive tape, and label the bag: “Hazardous Waste - Mercury.” The bag with the mercury waste should always be placed in the secondary container (metal or plastic with lid). The lid should be secured with an adhesive or electrician tape to prevent mercury escape in the case of accident. The secondary container should be labeled: “Waste Mercury UN 2809, RQ, UN151” to be ready for transportation.
8. Your NWSREP is responsible for transportation and disposal of the mercury waste. Phone your NWSREP to request retrieval of the mercury waste.

3.5. Logging of Temperature Readings. No matter what thermometer system you use, electronic or liquid in glass (LIG) you will enter the Maximum, Minimum, and At Observation temperature to the nearest whole degree into the WxCoder or IV-ROCS system in accordance with the instructions given by your NWSREP. If an electronic reporting system is not used, record your observation on a WS Form B-91 that will be provided by your NWSREP.

Remember the maximum and minimum temperatures are the highest and lowest temperatures to have occurred in the last 24-hours (i.e., between 8am to 8am, inclusive). The “AT OBSN” is the temperature at the time you take the observation (i.e., 8am). If you take the observation at 8am on June 3, then you enter the Maximum, Minimum, and Current (AT OBSN) values on the row that begins with the “3” in the date column (Figure B-35). If you take the observation at 6pm June 3, you still enter the values on the row that begins with the “3” in the date column.

DATE	TEMPERATURE F.		AT OBSN.	REMARKS (Special observations, etc.)
	24 HRS. ENDING AT OBSERVATION			
	MAX.	MIN.		
1				
2			28	
3	44	28	39	AM MIN 36
4	65	38	62	AM MIN 55
5	62	35	35	PM MAX 58
6				

Figure B-35. Proper Entries for Temperature Observations

Figure B-35 shows the correct method of recording minima for the past night that is higher than the 24-hour minima (see the REMARKS entries on the 3rd and 4th) and 24-hour maxima that is lower than the previous afternoon's maximum (see the REMARKS entry on the 5<sup>th</sup>).

Figure B-26 also illustrates the date, temperature, and remarks columns for the daily temperature observation. The scheduled time of observation for this cooperative observer is 8 A.M.

3.6. Common Errors to Avoid. While many eyes look at your data on its way to the archive at NCEI, it may not always be obvious if it happens to contain an error. For this reason you are asked to carefully review maximum and minimum values that look inconsistent. You should correct your entry or express your uncertainty in the Remarks section.

Take special care to understand and prevent these types of errors from occurring:

- a. Maximum temperature lower than the time-of-observation temperature at the previous observation (24 hours earlier). This error most frequently occurs when readings are taken in the afternoons and evenings.
- b. Minimum temperature higher than the time-of-observation temperature at the previous observation (24 hours earlier). This error most frequently occurs among observers who take morning readings.
- c. Maximum (and occasionally the minimum) temperature recorded on the day it occurred rather than on the day the thermometers were read and reset. For example, a morning observer records high and low temperatures for the past 24 hours at 7 a.m. on the 25th as being 88° and 62°. The observer knows the maximum of 88° occurred on the 24th (the previous afternoon), so the observer records the high temperature on the row marked the 24<sup>th</sup>. It should have been recorded on the 25th; because this is the day the instruments were read and reset.

The most common cause of errors “a.” and “b.” is the resetting of the thermometers between times of observation. Thermometers should only be reset immediately after the observation is taken at the standard hour each day.

The maximum temperature for the past 24 hours should be at least as high as the time-of-observation temperature both today and 24 hours earlier, and the minimum at least as low as today's and 24 hours ago. This error appears when the afternoon observer wants to record this afternoon's maximum temperature when it is lower than yesterday's afternoon maximum.

This situation usually arises when it was warmer yesterday than today. Today's maximum should be recorded in the REMARKS column. For example, “PM MAX 48” or “TODAY'S MAX 48,” and last night's minimum as “AM MIN 36.” **See Section 1.7, of this Appendix, for policy on when to perform quality control of observations, and review Figure B-2, for an example of how to properly log temperature observations.**

In summary:

Minimum Temperature: Has to be at least as low as the lowest of yesterday's and today's At Observation temperatures.

Maximum Temperature: Has to be at least as high as today's and yesterdays At Observation temperatures.

3.7. Reporting the Air Temperature Observations. Report the Maximum, Minimum, and At Observation air temperatures through your designated system, as instructed by your NWSREP. If you are unable to use electronic reporting, then use WS Form B-91 (Figure B-2).



## 4. PAN WATER EVAPORATION MEASUREMENTS

### 4.1 Measuring Evaporation.

4.1.1 Fixed Point Gage. Evaporation is measured by determining the amount of water required to bring the water level in the stilling well exactly to the tip of the pointed rod. Use the transparent measuring tube (Figure B-36) to add or remove water from the evaporation pan. When adding water, fill the measuring tube to the zero mark (the top mark on the tube), then pour (slowly) exactly enough water into the evaporation pan (not in the stilling well) to bring the water level to the tip of the fixed point. Read the level of water remaining in the measuring tube. If this reading is closest to the 12 mark, then, 0.12 inches of water has evaporated (or if it rained during the period, then evaporation has exceeded precipitation by 0.12 inches). See Figure B-37.

4.1.1.1 Evaporation Observation Entry (Ordinary). Water added to the pan to bring the pan level up to the fixed point in the still well is always entered as a positive value. The amount of evaporation is the summed amount of water poured from the tube into the pan to bring the water level up to the fixed point. Water removed from the pan is recorded as negative (see next section).

4.1.1.2 Evaporation Observation Entry if Rain Occurred. If precipitation has occurred since the previous observation, the water level may be above the tip of the fixed point. In this case, remove water by dipping the measuring tube into the water (i.e., to the zero level index mark, near the top) as many times until the pan level decreases to below the fixed point. Be sure to keep track of the number of times a full tube of water was removed from the pan. Write this to a notepad if necessary.

Next, fill the tube from another source (outdoor tap or water storage tank) up to the zero level, and then pour just enough water back into the pan to bring the level to the tip of the fixed point (Figure B-37). Deduct this amount from the total removed.

An alternative to bringing the water level below the fixed point is to remove enough water from the pan into the measuring tube to bring the water exactly to the fixed point, measuring the amount in the tube, and subtracting this from 0.15 inch. For example, if the tube is filled to the “5” level (0.05 inch), subtract 0.05 from 0.15. The amount removed by dipping is thus 0.10 inch. This is added to the amount removed (if any) by filling the tube from the pan as described in the previous paragraph.



Figure B-36. Transparent Measuring Tube and Stilling Well Inside the Pan

For recording purposes, water added is positive and water removed is negative. For example, if 0.24 inches of water is added, record this as +0.24. On the other hand, if rain has fallen and the measuring tube requires filling three times to bring the level below the fixed point, then 0.45 inches is deducted. If 0.06 inch of water is then added to bring the level back to the fixed point, enter the sum of -0.45 and +0.06, or -0.39, as the ‘Amount of Evaporation.’

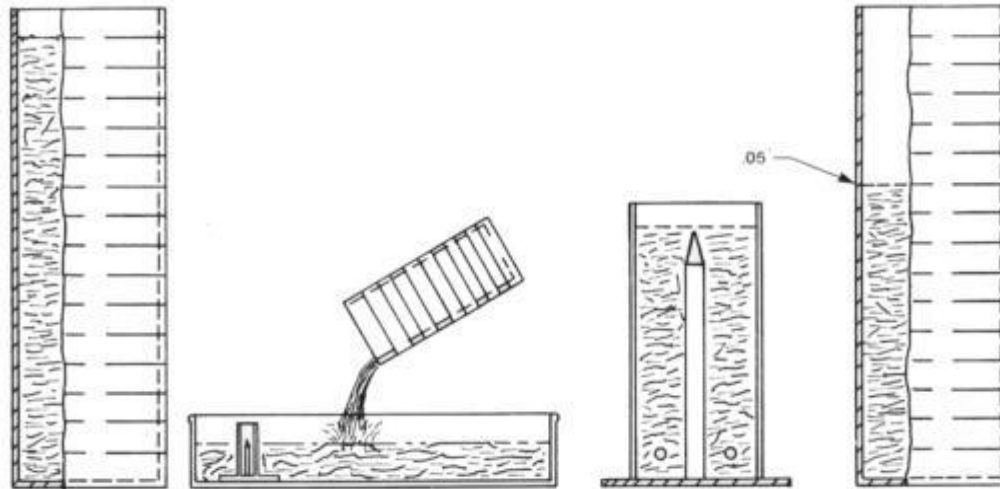

Figure B-37. Fixed Point Gage – Evaporation Measurements

4.1.2 Hook Gage: In older manuals it has been referred to as the ‘Spider Gage.’ The Hook Gage allows the water level to drop over the respective successive readings; this changes the exposure of the water surface to its surrounding environment. This gage has been replaced by the Fixed Point Gage, but will be used until it is no longer serviceable.

At the scheduled time of observation, place the Hook Gage on top of the stilling well in the pan. Refer to Figure B-36 for photo of the stilling well. Lower or raise the hook in the water until the point is below the surface. Slowly turn the adjusting nut until the point just pierces the water surface.

The numerals on the stem represent whole inches, and the intermediate graduations represent tenths of an inch. The figures on the circular scale represent hundredths of an inch and the intermediate graduations represent thousandths.

- a. Read to the nearest tenth of an inch which is the first graduation showing on the stem above the knurled adjusting nut.
- b. Read the circular scale on the adjusting nut to the nearest hundredth of an inch at the index.

Both readings from steps ‘a.’ and ‘b.’ are added and the sum represents the hook gage reading.

- c. Enter Hook Gage readings into your regular reporting system, as the ‘Gage Reading...’



Figure B-38. Hook Gage

Example: A scale reading of 32 on the stem indicates 3.2 inches; a scale reading between 85 and 86 on the circular scale indicated value between 0.085 and 0.086 or rounded to 0.09. Add the 3.2 and 0.09 to determine the Hook Gage reading, of 3.29 inches.

4.1.2.1 Evaporation Observation Entry (Ordinary). When no rain has occurred since the last scheduled observation, enter the reading as obtained directly from the Hook Gauge. The actual evaporation is the difference between the preceding observation’s entry and the current reading.

4.1.2.2 Evaporation Observation Entry if Rain Occurred. When rain has occurred since the last scheduled observation some calculation is required to get the evaporation amount.

Add the amount of rainfall to the previous day’s Hook Gauge reading (i.e., SUM). From this sum, subtract the current reading of the Hook Gauge. This is the 24 hour evaporation amount. (i.e., EVAP AMOUNT)

March 10 <sup>th</sup> , 8AM Hook Reading:	2.71
March 11 <sup>th</sup> , 8AM 24-Hr Precipitation:	<u>0.53</u>
SUM...	3.24

March 11 <sup>th</sup> , 8AM Hook Reading:	<u>- 3.12</u>
EVAP AMOUNT .....	0.12

**Note:** Due to small, unavoidable inaccuracies in measurements, and condensation of water in the evaporation pan, the water level sometimes may be higher than that of the previous day. In such cases, the computed value of the evaporation should be preceded by a minus sign (i.e., -0.01 inch).

Refer to Section 4.6 in this chapter, for how to report all elements for the complete Pan Evaporation observation.

#### 4.2 Secondary Observations Reported with the Evaporation Observation.

4.2.1 Wind Run from Totalizing Anemometer. Read the counter on the totalizing anemometer and enter the reading to the nearest whole mile. This entry relates to the number of miles of wind that has passed across the evaporation pan since the last scheduled observation. The entry is an accumulated number from day to day. For the column marked, '24-hour movement' you subtract yesterday's total from the value you entered as today's anemometer dial reading.

4.2.2 Water Temperature. At each day's scheduled observation take a reading of both the maximum and minimum temperature of the water in the Evaporation Pan. Generally water temperatures are taken from a submerged U-shaped MAX/MIN thermometer (Six's type) horizontally mounted on a plastic holder that rests on the bottom of the pan. This thermometer should be positioned on the south side of the pan to minimize direct rays of the sun. Maximum and Minimum temperatures are taken from the end of the metal indices nearest the respective side of the U-shaped mercury column. Reading and entries are recorded to the nearest whole degree.

Some of the Evaporation Pan sites use the long stem maximum/minimum digital thermometer (i.e., TW24). Read the maximum and minimum values and enter the values to the nearest whole degree and reset the digital thermometer. Follow instructions in Section 4.2.2.4.

4.2.2.1 Reading and Resetting the Six's Thermometer. Read temperatures to the nearest whole degree, as indicated by the end of the metal indices nearest the mercury columns. If possible, read while submerged. Then, remove the thermometer from the pan to reset the indices. To reset the thermometer, place a small magnet directly above one metal index. Move the magnet slowly toward the mercury column until the index touches the mercury. Gently lift the magnet away from the tube so the index will not spring away from its contact with the mercury. Repeat this procedure for the other index.

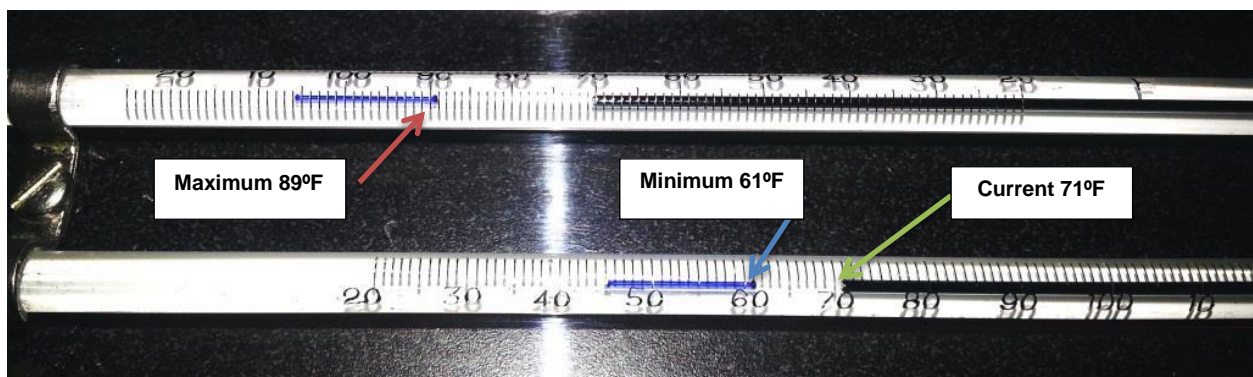

Figure B-39. Six's Thermometer Before Resetting.

The submerged-mount thermometer magnet comes with a small metal strip to bridge across the poles of the magnet and keeps it from losing strength. Replace the strip after each use. If the strip is lost, a nail or small metal piece may be used.

4.2.2.2 Rejoining Separated Mercury Columns. The mercury columns in a Six's thermometer are subject to separation and this causes inaccurate readings. The column should be joined as soon as possible. Remove the thermometer and holder from the pan. Do not remove the thermometer from either its plastic holder or float frame. Hold the thermometer near its bulb end and swing rapidly in an arc until the mercury column is rejoined.

Always perform this maintenance outdoors in a wide open area free of obstructions to avoid any object that you could be stuck and break the Six's thermometer. If a Six's thermometer does break, refer to Section 3.4, Mercury Clean-Up.

4.2.2.3 Six's Maintenance. Keep the Sixes thermometer assembly and plastic holder free from dust and sediment. Use a soft wet cloth for cleaning the unit. A very fine grade steel wool or SOS-type cleaning pad can be used to clean salt deposits from the thermometer bulb and tube.

4.2.2.4 Long Stem Digital Max/Min Thermometer – Operation. Be careful not to remove the tip of the probe from the water before reading the display. The TW24 records readings quickly and will store the Air Temperature to memory if the probe is removed from the water.

To observe water temperature, simply read the display, it should show the current temperature. Note: The normal operating condition is for the display to always be 'ON' while measuring temperatures in the pan.

Press the left button to display the 'Max' temperature.

Press the left button again, to display the 'Min' temperature.

Press the left button a third time to return to the 'Current' temperature.

Resetting the Max/Min: The Max/Min are set to the current temperature when the TW24 is turned OFF, and then back ON.

Press the right button and hold it for several seconds. This will turn the TW24 off.

Make sure the probe is in the water, and press the right button again. This will turn the TW24 back on, resetting the Max and Min for the next day. **Leave the TW24 in the ON mode and showing the current temperature.**

Return the thermometer to holder, and return cap to cover the display.



Figure B-40. TW24 Long Stem Max/Min Thermometer

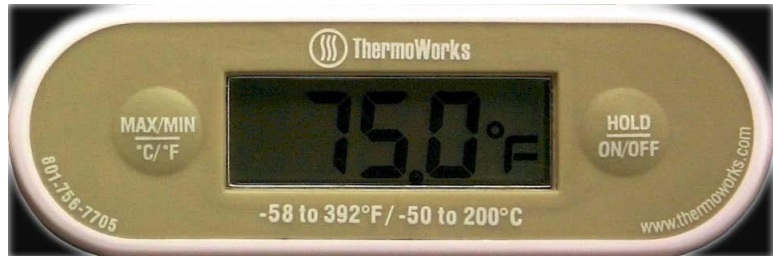

Figure B-41. On/Off Button is on Right Side

These readings are reported at the same time you report the official observation of evaporation pan water and total wind motion.

4.2.2.5 Maintenance of the Long Stem Digital Max/Min Thermometer. Do not drop the head of the TW24 in the water. It is water resistant, not water proof.

Please keep the head of the TW24 covered, except when reading for the daily observation. This way you will protect it from UV exposure.

If the TW24 will not turn 'ON', then it probably needs a new battery. Notify your NWSREP.

4.3 Routine Maintenance. Several times per month, inspect the evaporation pan for leaks. A leaking evaporation pan will render measurements useless. If a leak is discovered immediately notify your NWSREP and enter the date the leak was discovered and the date the pan was repaired or replaced, into the Remarks column of the observation report.

Clean the pan as often as necessary to keep it free from any substance that will alter the evaporation rate, such as oil films, algae, leaves, debris, or sediment. Oil films greatly reduce evaporation.

4.4 Algae Removal. Your NWSREP will supply you with eco-friendly Algaecide or Copper Sulfate. A small amount of eco-friendly Algaecide or Copper Sulfate when added to water in the pan will be effective. Follow instructions on package label for amount to apply for required concentration. The pan holds approximately 60 gallons of water when the water level is eight inches deep (i.e., two inches below the rim).

If algae is already present, phone the NWSERP because the Evaporation Pan may need to be thoroughly cleaned.

4.5 Accuracy Checks. Check the accuracy of the water temperature readings at least once a year when the pan is cleaned by removing the Six's thermometer from the pan and placing it in the instrument shelter. Allow enough time for the thermometer to dry and reach the air temperature. From the Minimum Thermometer, read the current air temperature as indicated by the end of the spirit column (not from where the index rests) without resetting the Minimum Thermometer. Then read the temperature from the Six's thermometer. Enter the readings in the "Remarks" column. If readings differ by 2.0°F or more, the NWSREP should be notified.

4.6. Reporting Pan Evaporation Observations. Record the observations as instructed by your NWSREP. One option is to record the observations to the WxCoder Superform. The form is illustrated in Figure B-42.

Note: Do not report data for any period in which the surface of the water has frozen into ice.

Day	Max temperature	Min temperature	At observator	Precipitation	Multi-d Accum	Snowfall	Snow depth	Evaporation	Max water temperature	Min water temperature	Anemometer dial reading	24 hour movement	Monthly precipitatio	Remarks
1	73	38	42	0.00	1	0.0	0	0.16	72	41	8289	47	0.00	
2	73	39	39	0.00	1	0.0	0	0.20	72	43	8339	50	0.00	
3	72	37	50	0.00	1	0.0	0	0.22	70	42	8408	69	0.00	
4	61	29	34	0.00	1	0.0	0	0.22	65	33	8500	92	0.00	
5	58	31	31	0.00	1	0.0	0	0.14	60	32	8575	75	0.00	
6	55	23	23	0.00	1	0.0	0	0.15	60	32	8639	64	0.00	
7	51	21	22	0.00	1	0.0	0	0.10	59	32	8688	49	0.00	
8	56	20	25	0.00	1	0.0	0	0.11	59	33	8735	47	0.00	
9	63	24	26	0.00	1	0.0	0	0.15	64	35	8792	57	0.00	
10	64	25	29	0.00	1	0.0	0	0.12	65	41	8839	47	0.00	
11	67	28	39	0.00	1	0.0	0	0.13	68	47	8889	50	0.00	
12	70	38	42	0.00	1	0.0	0	0.13	67	46	8928	61	0.00	
13	61	40	42	0.03	1	0.0	0	0.04	62	45	8982	54	0.03	
14	52	32	34	0.00	1	0.0	0	0.05	59	45	9027	45	0.03	
15	60	32	36	0.00	1	0.0	0	0.09	65	47	9072	45	0.03	
16	62	34	40	0.00	1	0.0	0				9122	50	0.03	Evap pan drained--end of season
17	56	31	32	0.16	1	0.0	0				9235	113	0.19	
18	48	24	26	0.00	1	0.0	0				9299	64	0.19	
19	55	23	26	0.00	1	0.0	0	0.00			9346	47	0.19	
20	61	26	44	0.00	1	0.0	0				9390	44	0.19	
21	64	37	44	0.00	1	0.0	0				9461	71	0.19	
22	56	38	40	0.06	1	0.0	0				9540	79	0.25	
23	56	30	30	1.02	1	3.0	3				9656	116	1.27	
24	39	26	27	0.14	1	1.0	2				9725	69	1.41	
25	37	24	25	0.00	1	0.0	1				9761	36	1.41	
26	37	18	20	T	1	T	1				9824	63	1.41	
27	37	18	33	0.00	1	0.0	T				9860	36	1.41	
28	44	30	41	0.00	1	0.0	0				9905	45	1.41	
29	54	36	36	0.00	1	0.0	0				9956	51	1.41	
30	60	32	33	0.00	1	0.0	0				5	49	1.41	
31	56	30	35	0.00	1	0.0	0				52	47	1.41	
56.70...	29.48...	33.74...	1.410000000...	4										

Figure B-42. Report Evaporation Observations into the WxCoder Superform

If you are unable to log and report your evaporation pan observations electronically, then log and report your daily observation to WS Form B-92, Record of Evaporation and Climatological Observations. See Figure B-43. Mail this form to the weather forecast office as instructed by your NWSREP.

Station		County			State		Date (Month & yr.)		Time of Complete Observation (Local time)		Standard Time in Use		RECORD OF EVAPORATION AND CLIMATOLOGICAL OBSERVATIONS								
DATE	AIR TEMPERATURE °F						PRECIPITATION				WIND		EVAPORATION (Inches & hundredths)		WATER TEMP. °F		ADDITIONAL DATA/REMARKS				
	24 Hours Ending at Observation		At Observation		Supplemental Readings at _____		Time of beginning	Time of ending	Time of beginning	Time of ending	24 Hour Amounts		At Obsn.	Anemometer Dial Reading (Miles)	24 Hour	Gage Reading or Amount Adjusted +		Reading When Tank Filled or Amount Removed -	Amount of Evaporation	24 Hours Ending at Observation	
	Max.	Min.	Dry-bulb	Wet-bulb	Dew Point	Dry-bulb	Wet-bulb	Dew Point			Rain, Melted Snow etc. (in. & hundredths)	Snow, Ice Pellets, Hail, Ice on ground (in.)								Max.	Min.
1																					
2																					
3																					
4																					
5																					
6																					
7																					
8																					
9																					
10																					
11																					
12																					
13																					
14																					
15																					
16																					
17																					
18																					
19																					
20																					
21																					
22																					
23																					
24																					
25																					
26																					
27																					
28																					
29																					
30																					
31																					
Sum																					
Avg.																					

WS FORM B-92 (5-89) U.S. DEPARTMENT OF COMMERCE NATIONAL WEATHER SERVICE OBSERVER STATION NUMBER

(PRES. BY WSOM B-17)

Figure B-43. WS Form B-92, For Observers Unable to Report Electronically



## 5. SOIL TEMPERATURE MEASUREMENTS

5.1 Time of Observation. Nearly all soil temperature stations also have instruments to record daily maximum and minimum air temperatures. Soil temperature readings should be taken at the same time each day. Generally, this will be between 7am and 8am or between 5pm and 8pm. The most common time is 7am, however, some observers take the observation in the evening (i.e., 6pm local time). The observer is asked to commit to the same time of observation each day. If you need to change the time of your daily observation, always phone or email your NWSREP first to communicate this change, and then commit to this hour. If recording instruments are used, the instruments should be checked daily to assure the logger is operating properly.

5.2 Maximum and Minimum Soil Temperature. Daily ranges in the soil temperature can exceed air temperature ranges in the shallow layers. This amplitude diminishes rapidly to about 1°F at depths of 18 to 24 inches. Observers are required to take the daily reading of the maximum, minimum, and current soil temperature for the 2 inch, 4 inch, and 8 inch depths, only. For depths of 12 inches and deeper, just the current temperature is recorded.

5.3 Palmer Soil Thermometer. The Palmer soil thermometer has been in general use for many years (Figure B-44). It is comprised of a 13 inch long mercury-in-steel sensor, connected to a flexible metal tube. The sensor drives a needle inside a glass enclosed display head.

The Palmer temperature needle pushes two set-pointers, one green, and one red, to indicate Minimum and Maximum temperatures respectively.

Read the maximum temperature from the red-color pointer to the nearest whole degree (See Figure B-44). Read the minimum temperature from the green-color pointer to the left of the Palmer's needle.

Use the note pad form WS Form B-82 (Figure B-1) to write-down the temperature readings so they can be entered later to your reporting system or form.

After you have written the Maximum, Minimum, and Current temperatures from the Palmer glass dial, then rotate the set pointers (one red, one green color), to gently touch the needle where it stands at the value of the current temperature.



Figure B-44. Palmer Soil Thermometer

5.3.1 Resetting Maximum and Minimum Pointers. After the maximum and minimum temperatures have been recorded; carefully reset the red (maximum) and green (minimum) pointers. The red pointer is reset first by bringing it into contact with the black (current temperature) pointer. Next, the green pointer is gently rotated to the opposite side of the black pointer. Do not press down on either pointer knob, as this will result in tension loss in the pressure washer and cause loose pointers.

During the resetting, check the “flex” of the black pointer. It should flex or move less than one degree in response to pressure from the red and green pointers. Movement in excess of this indicates either a loss of tension in the sensor system or too much drag tension in the maximum and/or minimum pointers. If lubrication does not correct the situation, replace the instrument.

5.4. Proper Entry of Maximum and Minimum Temperatures. To avoid making a data entry error in the soil temperature maximum and minimum observations, review Appendix B, Section 3.6. Three scenarios are described where errors have occurred. You are asked to carefully review your maximum and minimum values that look inconsistent. You should correct your entries, or express your uncertainty in the Remarks section.

5.5 Reporting Soil Temperature Observations. Record the soil temperatures to the nearest whole degree Fahrenheit, as instructed by your NWSREP. If you are unable to use electronic reporting, then use NWS Form 1009-ST (Figure B-45) to report the elements of the soil temperature observation. Be sure to report observations for each depth, if your site has multiple sensors.

FORM 1009-ST - **RECORD OF SOIL TEMPERATURE OBSERVATIONS** -  
 U.S. Dept. of Commerce - NOAA - NWS

STATION NAME <b>IWX</b>							MONTH	YEAR	OBSERVER				STATION INDEX NUMBER											
STATE <b>INDIANA</b>		COUNTY: Kosciusko					STANDARD TIME IN USE <b>E</b> "C" CENTRCCENCE				SUPERVISING NWS OFFICE													
DATE	<b>8 A.M.</b>							<b>5 P.M.</b>							Max/Min 24 hrs ending at _____ (if so equipped)									
	2 in.	4 in.	8 in.	20 in.	40 in.	60 in.	Surface Cover	2 in.	4 in.	8 in.	20 in.	40 in.	60 in.	Surface Cover	Max 1 in.	Min 1 in.	Max 2 1/4 in.	Min 2 1/4 in.	Max 4 in.	Min 4 in.	Max 8 in.	Min 8 in.	Surface Cover	
1																								
2																								
3																								
4																								
5																								
6																								
7																								
8																								
9																								
10																								
11																								
12																								
13																								
14																								
15																								
16																								
17																								
18																								
19																								
20																								
21																								
22																								
23																								
24																								
25																								
26																								
27																								
28																								
29																								
30																								
31																								

Figure B-45. Form 1009-ST for Soil Temperature Observations

## 6. RIVER STAGE MEASUREMENTS

6.1. Safety Precautions. There are three basic types of gauges to manually measure river stage levels; the staff river gauge, the wire weight gauge; and the profile gauge. The wire weight gauge measures river height with a winch that is mounted to the side of a bridge. The staff river gauge is a post or a vertical marker that is clearly visible from a safe observing location. The profile gauge, also known as a slope gauge, measures river height from a marker mounted flat on the ground on the riverbank.

Cooperative Observers who take river stage observations should be familiarized with the safety procedures given by the *NOAA Occupational Safety and Health Manual* (NWSM 50-1115). Read and take the important precautions identified in NWSM 50-1115, Procedure 1, ‘*Fall Protection.*’ Do you have the necessary lanyards, D-rings, fall arrest systems if you are taking observations from a bridge or any other elevated structure? Do you have proper protective wear to prevent falls on ice covered surfaces?

Read and take the important precautions identified in NWSM 50-1115, Procedure 2, ‘*Working Alone.*’ Communicate to your NWSREP any limitations or risks you have in taking the river observation and the conditions in which you may be unable to observe and report the river stage.

If the ground or roadway conditions near the river gauge site have deteriorated, or the wire weight gauge, staff gauge, or profile gauge equipment cannot be maintained at the site, notify your NWSREP. The NWSREP will determine whether to close the site or relocate the gauge.

**Caution: Do not risk injury to collect data.**

**Bridge Cautions:** Always be vigilant of traffic conditions and the risk presented by passing vehicles. Do not park or stand in locations that would cause traffic to be diverted.



Figure B-46 – Observer at Wire Weight Gauge

6.2. Observation Requirements. River stage and precipitation observations should be taken at 7 a.m. each day unless otherwise specified by or agreed upon with your NWSREP. Special observations are taken at 1 p.m., 7 p.m., and 1 a.m. only when a report is required or when the cooperative observer believes an emergency situation has occurred. Precipitation readings at river cooperative stations are taken with, non-recording gauges (Appendix B, Section 2, *Precipitation Measurements*).

Obtain a stage measurement at the river crest, recording the approximate time of occurrence. It is also very helpful to take observations, both as the river begins a significant rise and as it recedes from a crest. **Do not risk injury to collect data!** These reports, even when not transmitted, will be valuable input to computer models that relate precipitation to river stage, and to determine the relationships of river stages at different points on the river.

6.2.1 Criteria Reporting Stations. There are two types of reporting stations, Daily and Criteria. The purpose of a Criteria reporting station is to alert the weather forecast office of the times when critical stages (i.e., flood levels) are reached, so the NWS can issue warnings to help save lives and property. Criteria reporting stations are sites where the observer has agreed to take and report river observations four times per day as instructed by the NWSREP.

During a criteria event (i.e., flooding), as soon as the river stage reaches the specified criteria level, the observer immediately reports the level to the weather forecast office. If the river stage continues to exceed criteria, extra reports are sent at 1 p.m., 7 p.m., and 1 a.m., as instructed.

For daily reporting stations, the observer continues to report river stage on a daily basis unless asked specifically by the NWSREP to take and report extra observations at 1 p.m., 7 p.m., and 1 a.m., until the stage falls below a specified level.

6.2.2 Daily Precipitation Reporting. Throughout the year, even when stages are below criteria, the observers at Criteria Reporting Stations should report both precipitation and river stage at 7 a.m. every day into the system as instructed by your NWSREP (i.e., WxCoder).

Always report the river stage and the precipitation together. If no precipitation has occurred, the daily record from both types of stations should indicate 0 or 0.00.

**Note:** When the rain gauge measurement reaches a criteria value (usually 0.50 inch), an initial report should be communicated to the WFO and any additional 0.50 inch amounts. The criteria are determined locally.

6.2.3 Additional Elements to Report. In addition to precipitation you may include the following information to your official River Stage report, if instructed by your NWSREP:

- a. Condition of river at the gauge site. (i.e., Fast Flow; Average Flow; No Flow; Dry River; Floating Ice; Shore Ice; Completely Iced).
- b. The tendency of the river stage (rising “R”, falling “F”, or steady “S”). Refer to the previous day’s observation taken at 7 a.m., if that is that last hour observed.
- c. The depth of snow and ice on the ground (nearest whole inch).
- d. The water content of snow and ice (nearest tenth inch), if instructed by your NWSREP.
- e. The weather at the observation time (clear, cloudy, rain, snow, etc.).

- f. In the Remarks section, enter special comments such as snow melting slowly or rapidly, unusually heavy rainfall in a short period of time (e.g., 1.54" in 30 minutes), ice breaking up or an ice jam forming on the river, for example.

### 6.3. Wire Weight Gauge Observation.

The process of determining the Check-Bar elevations is calculated from the “gauge zero.” Follow safety considerations outlined above in Section 6.1

Take the readings as follows:

- a. Unlock the case (Figure B-47) and gently open the cover. If the cover jams and will not swing freely, do not force it open. Close, relock, and submit a repair order. Inspect the wire on the drum for even windings that touch each other.
- b. Grasp the crank handle (Figure B-47) and release the pawl. The pawl engages the sprocket. The sprocket is seen about the hub of the Crank Handle.

**Caution:** If the handle is released when the lock is not engaged the unit will backlash. Severe damage to the equipment or injury is possible.

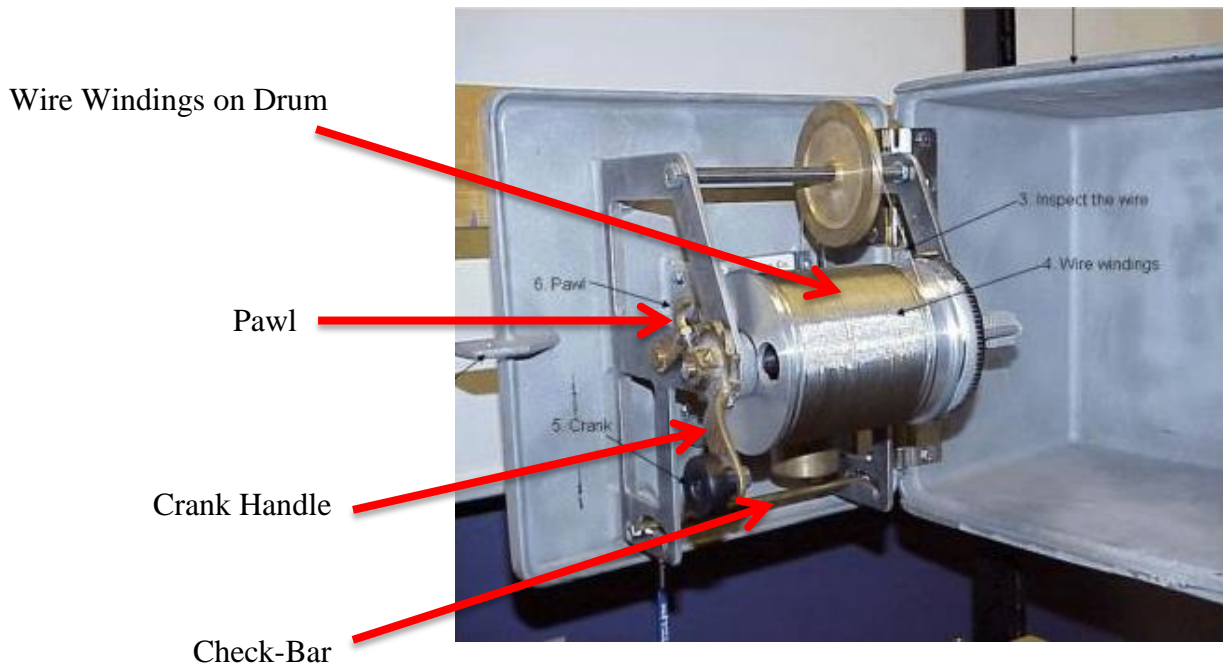

Figure B-47 – Side View of Wire Weight Gauge Components

- c. Lower the weight (Figure B-49) to just touch the Check-Bar, which is read while in the forward position. Read the Check-Bar elevation and record it. At the beginning, middle, and end of each month enter this reading into WxCoder or if

electronic reporting is unavailable, use the WS Form B-91.

- d. Raise the weight and slide the Check-Bar to the rear position. Lower the weight to the water surface and read this elevation just as the weight touches the water while descending. Average the peaks and troughs when water surface is rough. Repeat this process at least once. If the point of contact with the water surface is difficult to determine, it may be necessary to strum the cable or to swing the weight in a pendulum motion up and downstream to obtain an accurate reading.

The counter (Figure B-48) displays units of feet. The index wheel displays units of tenths and hundredths of a foot and is read at the pointer (Figure B-49).

Counter Indicates 23-feet.



Figure B-48 – Reading the Wire Weight Gauge

- e. Every day, record the reading obtained in step “d” in the "GAUGE READING AT" column in WxCoder, or in WS Form B-91 (Figure B-2), if instructed by your NWSREP.
- f. Engage the pawl and crank the weight to its original position within the gauge. Slide the Check-Bar to the forward notch. The crank handle should now be located in the rear position. This will allow the cover to close without touching the outer tip of the crank handle.
- g. Close the cover and lock the case.

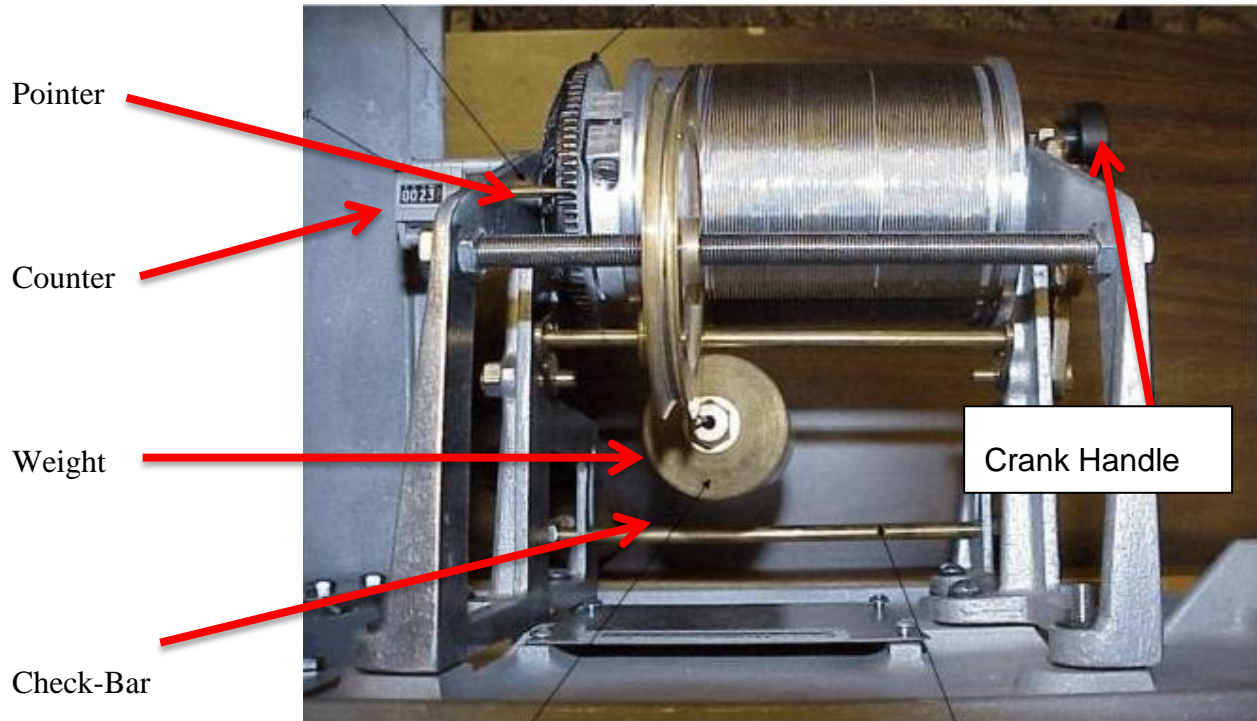

Figure B-49. Top View of the Wire Weight Gauge Components

6.4. Staff Gauge Observation. Observe where the water level intersects the staff gauge along the index markings. Take note of the large numerals that indicate the depth in whole feet, and then take note of the gradations that indicate tenths of a foot. Make a note of this value for transfer to your chosen method of dissemination. Report this value to the weather forecast office, as instructed by your NWSREP.



Figure B-50 – Reading the Staff Gauge



6.5. Profile Gauge Observation. Observe where the water intersects the sloped surface of the Profile Gauge. Take note of the numerals and markings that are spaced at tenths of a foot along the gauge.

Write down the value for where the river water intersects the sloped gauge. Report this value to the weather forecast office, as instructed by the NWSREP.

Note: The Profile Gauge is also referred to as the ‘Slope Gauge.’



Figure B-51 – Reading the Profile (Slope) Gauge

6.6 Reporting River Levels. Using the method your NWSREP advises, report the river stage to your weather forecast office (WFO) on a daily basis. Your NWSREP may advise you to record the river stage level to the WxCoder system. For those observers who are unable to record electronically, use the WS Form B-91 (Figure B-2) and mail to the WFO.

## 7. ATMOSPHERIC PHENOMENA OBSERVATIONS

7.1. Introduction. The following atmospheric phenomena should be observed and reported as instructed by your NWSREP: tornadoes, waterspouts, funnel clouds, thunderstorms, damaging winds (including squalls), fog, mist, haze, smoke, dust, frost, and any form of precipitation. Recording haze, smoke, dust and frost is optional, except when dangerous, i.e., to travelers or crops. Observations of these phenomena are an important part of the record from climatological stations, and they are often the only written account of these occurrences from the observer's area. **Except for precipitation, no instruments are required to record these phenomena.**

Damaging and life-threatening phenomena, especially tornadoes, should be reported immediately to the NWS office or as directed by the NWSREP. A report should give at least two observations of the storm in order to determine direction and speed. State its compass location (i.e., SSW and distance, i.e., 3 miles) and current time to nearest minute; and repeat the observation in five minutes unless you are taking shelter. Do not risk injury to collect data.

7.2. Tornadoes, Waterspouts and Funnel Clouds. Tornadoes and funnel clouds are nearly always associated with intense thunderstorms. While some waterspouts may develop in the absence of thunderstorms and often are much less destructive, others are tornadoes that have formed or moved over water, and are just as dangerous over water as land.

7.2.1 Tornado. Tornadoes are local storms usually of short duration that consist of a violently rotating column of air extending from a thunderstorm to the ground (Figure B-52). A tornado will usually appear hanging from the bottom of the storm cloud, generally close to, but outside the area in which rain is falling.

Part, or all, of the funnel may be invisible if the air is dry, but the tornado can still often be identified by the rotating particulate matter, especially near the ground, and in intense tornadoes, by a loud roaring sound. Rotating debris not associated with clouds are whirlwinds (dust devils-see Figure B-73) rather than tornadoes.



Figure B-52. Tornado

Tornadoes do their destructive work from strong rotary winds. As a tornado passes over a building, the winds twist and rip from the outside (Figure B-53). Walls collapse or topple outward, windows explode, and the debris of this destruction is driven through the air with dangerous force. Heavy, objects like machinery and railroad cars can be lifted and carried by the wind for considerable distances.

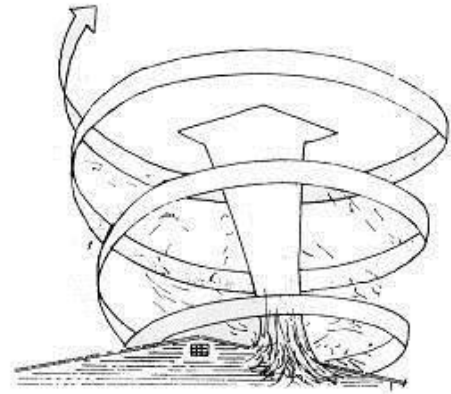

Figure B-53. Winds Associated with a Tornado

7.2.2 Funnel Cloud. A funnel cloud is a rotating column of air that is not in contact with the ground. Funnel clouds form at the base of dark, heavy cumulonimbus clouds and develop downward. Some never reach the ground. Others reach the ground (becoming tornadoes), then rise again or dissipate. See Figure B-54.



Figure B-54. Funnel Cloud

7.2.3 Waterspout. Over a large body of water, a tornado is called a waterspout. It rises from the water into the cloud in an upward spiral. Waterspouts are weaker than most tornadoes, but can still be dangerous. Waterspouts can overturn small boats, damage ships; do significant damage when hitting land, and cause fatalities. See Figure B-54.



Figure B-55. Waterspouts

7.3. Thunderstorm. For record purposes, a thunderstorm is considered in progress when thunder is heard, whether or not rain is falling or lightning is seen. The intensity may vary from occasional distant thunder to very frequent, sharp thunder with heavy rain, sometimes associated with strong winds and hail. See Figure B-56.



Figure B-56. Distant Thunderstorm

7.4. Damaging Winds, Squalls, and Gusts. Winds are considered “damaging” when crops, buildings, or other property has been damaged or destroyed. See Figure B-57. A squall is a sudden, violent wind, often accompanied by rain or snow. Gusty winds are characterized by sudden, periodic increases in speed. There are noticeable differences in speed between the peaks and lulls. All of these often occur with thunderstorms, or they can occur alone. The derecho (day-RAY-cho) storm is a rare and especially destructive thunderstorm. It is a long-lived fast moving complex often bow-shaped. Derechos have a rear-inflow jet and produce sustained downbursts with damaging straight-line winds that can reach hurricane force. Derechos are large, 100-miles or more in length, and travel hundreds of miles.



Figure B-57. Microburst

7.5. Hydrometeors. A hydrometeor is any form of atmospheric water (liquid or frozen) or water vapor that (a) falls through the atmosphere, such as rain or snow; (b) is suspended in the atmosphere, such as fog (c); is blown from surfaces by the wind, such as blowing snow or blowing spray; or (d) is deposited on objects, such as freezing rain (glaze).

7.5.1 Forms of Precipitation. Hydrometeors include precipitation in all its forms. It may be continuous, intermittent, or showery. Dew is not considered precipitation. The intensity is classified as light, moderate, or heavy. Precipitation is observed in the following forms:

- a. Rain - Rain is drops of water in liquid form falling from the sky, the individual drops are larger than 0.02 inch in diameter.
- b. Drizzle - Drizzle is fairly uniform precipitation composed exclusively of fine droplets (less than 0.02 inch in diameter), uniformly dispersed, that may appear to float with the air currents.
- c. Ice Pellets - Ice Pellets are round or irregularly-shaped pellets of ice with a diameter of 1/5 inch or less, either transparent or translucent. Ice Pellets usually rebound when striking hard surfaces, making a sound on impact. The following two types of ice pellets are observed:
  - (1) Hard grains of ice consisting of frozen raindrops or melted and re-frozen snowflakes (often called sleet).
  - (2) Pellets of snow encased in a thin layer of ice. These rarely bounce on impact.

The first type (1) falls as continuous precipitation, the second type (2) is associated with showers.

- d. Freezing Rain - Freezing Rain is rain or drizzle that falls in liquid form, but freezes to objects and/or on the ground. It forms a smooth coating of transparent ice layers (glaze). Ice storms result from heavy coatings of glaze and may do great damage to trees, shrubs, and telephone and power lines, creating unsafe conditions.



Figure B-58. Glaze Ice

- e. Hail – A hailstone is a piece of ice, often round or in irregularly shaped lumps, falling individually or several pieces frozen together. They range from 1/5 inch to two or more inches in diameter. Hail usually consists of alternate opaque and clear layers of ice (Figure B-59). Hail is normally associated with thunderstorms and temperatures above freezing. Hail can cause serious damage to anything it strikes. Crops may be destroyed and livestock injured.



Figure B-59. Hail

- f. Snow - Snow is white or translucent ice crystals, mostly in six-pointed star form, often mixed with simple crystals. Snow occurs under conditions similar to those of rain, but the air temperature aloft is freezing or lower.
- g. Snow Pellets - Snow Pellets are white, opaque grains of ice, round or conical, 1/16 to 1/4 inch in diameter. The pellets are crisp and easily compressed and may bounce or burst when striking hard surfaces. See Figure B-60.



Figure B-60. Snow Pellets

- h. Snow Grains (granular snow) - Snow Grains are minute opaque, branched, star like snowflakes or very fine simple crystals. They are smaller than snow pellets and usually fall in small quantities from low stratified clouds. They do not bounce or shatter on impact. See Figure B-61.



Figure B-61. Snow Grains

Both snow pellets and snow grains should be recorded.

7.5.2 Hydrometeors Other Than Precipitation.

- a. Fog - Fog is minute water droplets suspended in the atmosphere to form a cloud at the earth's surface. There is no visible downward motion. The horizontal visibility is  $\frac{1}{2}$  mile or less. It is called ground fog if the depth is less than 20 feet. Fog differs from haze by its dampness, and gray color. See Figure B-62.



Figure B-62. Fog

- b. Mist - Mist is similar to fog except the horizontal visibility is greater than  $\frac{1}{2}$  mile, but less than 7 miles. See Figure B-63.



Figure B-63. Mist

- c. Ice Fog - Ice Fog is minute suspended particles in the form of ice crystals and/or needles. It occurs at very low temperatures ( $-20^{\circ}\text{F}$  or colder), usually in clear, calm weather at high latitudes. It does not produce rime or glaze on objects. See Figure B-64.





Figure B-64. Ice Fog

- d. Dew - Dew is liquid water that has condensed on objects on or near the surface of the earth with above freezing temperatures. Dew occurs on calm, clear nights. See Figure B-65.
  
- e. Frost - Frost forms when thin ice crystals shaped like scales, needles, feathers or fans, develop when a given surface cools below the dew point of the air surrounding it and when the air temperature is below freezing. The surface temperature of the object has to be 32°F or lower. Frost can occur on the ground when the air temperature at the instrument shelter level is several degrees above freezing. It is the same as hoarfrost. See Figure B-66.



Figure B-65. Dew



Figure B-66. Frost Formed on Window

- f. Freeze - Freeze is the condition of the lower atmosphere when the temperature of surface objects is 32°F or lower. A freeze may or may not be accompanied by a deposit of frost (Figure B-66). When vegetation is injured by a relatively low temperature (with or without a frost), the condition is termed a freeze.

During a freeze, the air at the instrument shelter level may be above 32°F, although the ground is 32°F or colder. This occurs most frequently during calm, clear nights, with the greatest temperature difference near sunrise.

Freezes are classified as follows:

- (1) Light Freeze - Little destructive effect on vegetation, except to tender plants and vines. Shelter level temperatures are often above freezing but drop below freezing for a short period at the surface.
  - (2) Killing Freeze - Widely destructive to vegetation. It is often defined as a sufficiently severe freeze to cut short the growing season. Temperatures at thermometer level are generally below freezing. This is sometimes called a "killing frost."
  - (3) Hard Freeze - Staple vegetation is destroyed. The ground surface is frozen solid under foot, and heavy ice forms on puddles and other exposed water surfaces. It is colder and more prolonged than a killing freeze.
- g. Rime - A white or milky and opaque granular deposit of ice formed by the rapid freezing of super cooled water droplets of fog, as they impinge on exposed objects. It is denser and harder than hoar frost, but lighter and softer than glaze. See Figure B-67.



Figure B-67. Rime Ice

- h. **Blowing Snow** - Blowing snow consists of particles of snow raised from the surface up to six feet (eye level) and higher (Figure B-68) by strong turbulent winds. It is blown about in sufficient quantities to restrict the horizontal visibility. It is called “drifting snow” if limited to below eye level. Blowing and drifting snow should be recorded when causing damage, such as blocking roads or exposing seeded fields.



Figure B-68. Blowing Snow

7.6. Lithometeors. Lithometeors are visible phenomena suspended in the air that are not associated with water vapor. Examples are haze and smoke.

7.6.1 Haze. Haze consists of fine dust or salt particles suspended in the air in sufficient quantity to reduce the visibility. It resembles a uniform veil that subdues all colors. See Figure B-69.



Figure B-69. Haze

Dark objects have a bluish tinge. Bright objects (the sun or distant lights) appear a dirty yellow or have a reddish hue. Haze may be caused by a variety of substances, including dust, salt, smoke particles from distant fires, volcanic ash, and pollen.

7.6.2 Smoke. Smoke is suspended particulate matter resulting from combustion. Smoke will cause the disk of the sun at sunrise and sunset to appear very red or to have a reddish tinge at other times of day. Smoke coming from a great distance, such as from forest fires or volcanoes, usually has a light grayish or bluish color. As smoke continues traveling from its source, the larger particles drop out, leaving haze. See Figure B-70.



Figure B-70. Smoke

7.6.3 Dust. Dust is fine particles of dust or sand suspended in the air, often as the result of a dust storm or sand storm that may have occurred at or far away from the observing site. It imparts a tan or gray hue to distant objects. The sun's disk is pale, colorless, or tinged yellow.

Dust manifests itself in the following additional forms.

- a. Blowing Dust - Blowing dust is dust picked up locally from the surface and blown about in clouds or sheets, reducing the horizontal visibility to 6 miles or less. See Figure B-71.



Figure B-71. Blowing Dust

- b. Dust Storm - A dust storm is blowing dust reducing the visibility to 1/2 mile or less. A dust storm usually arrives suddenly in the form of an advancing dust wall (Figure B-72) which may be miles long and several thousand feet high. Ahead of the dust wall the air is very hot and the wind usually light.



Figure B-72. Dust Storm

- c. Dust Devil - The dust devil is a small vigorous whirlwind, usually of short duration, made visible by dust and debris picked up (Figure B-73)

from the surface. Dust devils usually occur on hot, calm afternoons with clear skies. They are seldom intense enough to cause appreciable damage.



Figure B-73. Dust Devil

7.6.4 Blowing Sand. This is sand that is picked up from the surface of the earth by the wind and blown about in clouds or sheets, reducing the visibility to 6 miles or less. It is called a sandstorm when the wind is very strong and the visibility is reduced to 5/8 of a mile or less. See Figure B-74.

**IMPORTANT:** Road hazards created by dust storms and sand storms should be reported immediately to the Weather Forecast Office. Do not risk injury to collect data.



Figure B-74. Sandstorm

7.7. Electrometeors. An electrometeor is a visible or audible display of atmospheric electricity.

7.7.1 Aurora. The aurora, frequently known as the Northern Lights, in the northern hemisphere, is a luminous phenomenon of arcs, bands, or curtains of light in the high (and occasionally middle) latitudes and at very high altitudes (Figure B-75). Aurora is usually white, but they may have other colors. The lower edges of the arcs or curtains are usually well defined, while the upper edges are not. The aurora is caused by electrically charged particles ejected by the sun, acting on the rarified gases of the higher atmosphere. The particles are channeled by the earth's magnetic field, so the bases of the curtains are pointed toward the earth's magnetic poles.



Figure B-75. Northern Lights

7.7.2 Thunder. This is a sharp rumbling sound which accompanies and follows lightning discharges. It is caused by rapidly expanding gases along the channel of a lightning discharge.

7.7.3 Lightning. Lightning is the flash of light from a sudden visible electrical discharge (Figure B-76) produced by thunderstorms. It takes the following forms:

- a. Cloud-to-Ground - Bolts of lightning occurring between the cloud and the ground.
- b. In-the-Cloud - Lightning within the cloud. The streaks are not visible from the ground.
- c. Cloud-to-Cloud - Streaks of lightning from one cloud to another, or from one part of a cloud through cloudless air to another. The streaks are visible from the ground.



Figure B-76. Lightning

- d. Cloud-to-Air - Lightning from a cloud into the air, but not striking the ground.

7.8. Atmospheric Optics. Sunlight or moonlight passing through ice crystals, cloud droplets, and rain drops can produce visible images in the shape of halos, arcs, bright patches at fixed angles from the sun or moon. These images are produced when sunlight or moonlight is reflected, refracted, diffracted, or interfered as it passes through the hydrometeors. The following types are observed.

7.8.1 Halo Phenomena. This is a group of phenomena in the form of rings, arcs, pillars, or bright spots produced by the reflection or refraction of sunlight or moonlight by ice crystals suspended in the atmosphere.' Cirrus and cirrostratus clouds often produce halos. The rings appear at 22 arc-degrees from the sun or moon due to the geometry of the ice crystals. A bright spot along the halo is referred to as a 'sun dog' or formally as a 'parhelion.' See Figure B-77.



Figure B-77. Halo with Sun Dogs

7.8.2 Corona. A corona is one or more sequences of small colored rings centered on the sun or moon. A corona is usually only a couple of arc-degrees in diameter and closely centered on the sun or moon. All colors may not be visible. Colors may be repeated irregularly, causing iridescence. Coronas are produced by sunlight or moonlight shining through thin clouds consisting of water vapor. See Figure B-78.





Figure B-78. Corona

7.8.3 Rainbow. A rainbow is a group of concentric arcs produced on a “screen” of falling precipitation by the light from the sun or moon. In some cases a double rainbow may be seen (Figure B-79) with the weaker bow being outside the stronger and having the sequence of colors reversed.



Figure B-79. Double Rainbow

7.8.4 Fog Bow. A fog bow is primarily a rainbow consisting of a white band which appears on a screen of fog. It is usually fringed with red on the outside and blue on the inside. See Figure B-80.



Figure B-80. Fog Bow

7.9 Reporting and Recording Hazardous Weather. While all phenomena should be recorded on the forms used by the observer to record the climate elements, only a few of the phenomena need to be reported in real-time.

7.9.1 Real-Time Reporting. Hazardous weather and the resulting after-effects that threaten lives and property should be reported to the Weather Forecast Office and, in many cases, to the police or other emergency preparedness offices, as soon as possible. This will greatly assist in the issuance of accurate warnings for areas in the path of the storm.

Your NWSREP provides information and trains you how to discern and report the severe weather through the SKYWARN program (<http://www.weather.gov/skywarn>). Personal safety guidelines are found in the NWS document, *The SKYWARN® Weather Spotter Program*. It is known as “Directive 10-1807” (<http://www.nws.noaa.gov/directives/sym/pd01018007curr.pdf>). In addition, your NWSREP can order you a 72-page booklet, *Weather Spotter’s Field Guide* from the NWS logistics support center. It has an agency stock number: YPA-201154.

7.9.1.1 Reporting Tornadoes, Waterspouts, and Funnel Clouds. Whenever a tornado, waterspout, or funnel cloud is observed, you should immediately contact your designated NWS office, if possible, by phone or other designated means, giving the following information:

- a. Distance and direction from the observing location.
- b. Direction toward which it is traveling.
- c. Time it was observed.

**Do not risk injury to collect data.**

7.9.1.2 Reporting Other Phenomena. Using your normal reporting method (i.e., WxCoder), enter Other Phenomena information to the “Remarks” field.

7.9.2 Recording Hazardous Weather. **Do not risk injury to collect data.**

7.9.2.1 Tornadoes, Waterspouts, and Funnel Clouds. After you have informed your local NWS office of the hazardous weather, use the Remarks field in WxCoder to enter as many of the following as possible: time of occurrence, direction and length of path, width of the path. Also describe any destruction from wind and hail, and report any injuries, deaths, or other relevant circumstances. If you are unable to record electronically, then use the printed WS Form B-91.

7.9.2.2 Thunderstorms. After you have informed your local NWS office of the hazardous weather, use the Remarks field in WxCoder to log the location of the thunderstorm in terms of compass bearing (i.e., WSW) and distance from your COOP site (i.e., 3 miles). Update your observation in five minutes, in order to calculate the direction and approximate speed of movement. Log this to the Remarks field. If you are unable to record electronically, then use the printed WS Form B-91.

7.9.2.3 Other Phenomena. Enter other phenomena in the “Remarks” field using your normal reporting method. Include information on damage, deaths, or injuries, if any. If you are unable to record electronically, then use the printed WS Form B-91.